

🇬🇧 2019

TECHNICAL & ESD FURNITURE ANTISTATIC EQUIPMENT



 **DIPPAUL**

VIKING



ABOUT US

By 2019, DIPAUL group has accumulated over 25 years of significant experience in electronics and semiconductor industries market, offering turnkey solutions, technologies and equipment for military-industrial and aerospace sectors, contract manufacturers, research and educational organizations, service and repair providers, telecommunication operators and others.

Over 16 years ago, knowing customers' needs and requirements, DIPAUL company started manufacturing modular workstations for electronics devices assembly under VIKING technical and ESD furniture brand. We were the first in Russia to develop new technologies and use modern materials to manufacture antistatic furniture, which by now resulted in becoming a leading Russian producer of ESD workbenches, storage units and additional equipment for electronic industry manufacturers. Since 2016, DIPAUL also started manufacturing heavy-duty technical furniture for mechanical engineering. Since 2017 our range includes dry storage cabinets for moisture-sensitive components and materials safekeeping.

Dipaul group has implemented dozens of equipping projects for such Russian companies as Transneft, Gazprom, Rosenergoatom, Russian Space Systems and international companies like Samsung Electronics, LG Electronics, Volkswagen Group, Nissan Manufacturing, Elcoteq, TPV Technology, and Foxconn.

VIKING ESD and technical furniture manufacturing site is located near Saint Petersburg and occupies the territory of over 6.000 square meters. We constantly monitor manufacturing process and quality of our products on all stages, which is acknowledged by ISO 9001:2015 quality management systems certificate. Being a member of IEC committee for ESD, we adjust engineering and manufacturing processes according to latest requirements of IEC 61340 standard.

VIKING TECHNICAL AND ESD FURNITURE

Today VIKING technical and ESD furniture brand offers a wide range of different modular workstations, ESD storage and transportation furnishing solutions, and a range of antistatic equipment.

VIKING technical furniture is distinguished by:

- Wide range of functional, convertible and interchangeable modules for each particular employee;
- Adjustment, layout and customization according to clients' specific needs;
- Possibility of modernization and refitting after the purchase;
- Strict compliance with the international antistatic standard IEC 61340.

VKG TOOLS ESD EQUIPMENT

Besides a broad line of furniture, we offer a range of antistatic products and consumables to fully equip ESD-protected areas. Among them, one can find garments, storage and transportation means, monitoring and audit devices. These products are sold under VKG TOOLS brand.

In 2013 DIPAUL group opened its branch office and a central distribution warehouse in Prague (Czech Republic) to provide closer support to its partners and distributors in the European region. Dipaul s.r.o. works on developing business relations with EU and ME distributors, supplies VIKING products from Czech warehouse to customers and ensures informational and technical support.

This catalog is informational. Minor amendments/changes in products exterior, composition and technical characteristics are permitted. Graphic images of units are schematic and should not be perceived as engineering drawings.

TABLE OF CONTENT

VIKING technical furniture Configurator	4
3D online workspace Planner	5
Our customers	6
Technical&ESD furniture	8
- VIKING workplaces series	9
- ALPHA series workbenches	10
- ALLIANCE series workbenches	12
- ALLIANCE automatic workbenches	14
- GAMMA series workbenches	16
- CLASSIC series workbenches	18
- COMFORT series workbenches	20
- CONSTANT series workbenches	22
- OSTROV series workbenches	24
- VERSTAK series technical workbenches	26
- TITAN series heavy duty technical workbenches	28
- Specialized workbenches	32
- Specialized workbenches for optical fiber handling	32
- Wire harness workbench	34
- Wire harness workbench accessories	35
- Customized layouts	36
- Workplaces additional equipment	38
- Drawer units	42
- Movable tables and carts	46
- Movable trolleys	48
- Cabinets and wardrobes	50
- Dry storage cabinets	52
- Shelving	55
- Modular counters	56
VKG tools antistatic equipment	58
- ESD chairs	58
- Grounding and additional equipment	60
- ESD garments	62
- Cleanroom garments and accessories	64
- Purex Fume extraction systems	66
- ESD storage and packaging	68
Catalog legend	73

VIKING TECHNICAL FURNITURE CONFIGURATOR



Most VIKING technical and ESD workbenches consist of functional and interchangeable modules to provide maximum flexibility in creating customized workstations, which satisfy any specific working process requirements. It may become an uneasy process to make a choice of elements guided solely by modules' description and codes and thus assemble certain set. With our online service – VIKING technical and ESD furniture Configurator (<https://viking-esd.com/constructor>), any user is interactively guided along the process of workbench assembling. Thus, it is much easier to make the right choice.

VIKING technical and ESD furniture Configurator helps to choose necessary basic modules and additional units of a required workstation online. It simplifies the process of assembling a workbench set, saves time and helps to avoid possible mistakes in modules compatibility. While assembling a workbench in online configuration tool one also chooses version (technical or ESD) and color (light gray RAL 7035 or dark gray RAL 7012) where applicable.

After choosing required options and elements one can place an order for chosen set to any VIKING official distributor online, print the individual set or use the picture and the list of modules for future orders.

VIKING technical furniture Configurator is also useful for workstations future amendments. Any time after the purchase customer can add or change certain modules of a workstation so that it meets new requirements of the manufacturing process.

Online Furniture Configurator

Most VIKING technical and ESD workbenches consist of functional and interchangeable modules to provide maximum flexibility and help customer create customized workplaces, which satisfy any specific working process requirements. It may become an uneasy process to assemble certain set and make a choice of elements guided solely by modules description and codes. With our online service – VIKING technical and ESD furniture Configurator, which interactively guides user along the process of workbench assembling, it's much easier to make a right choice.

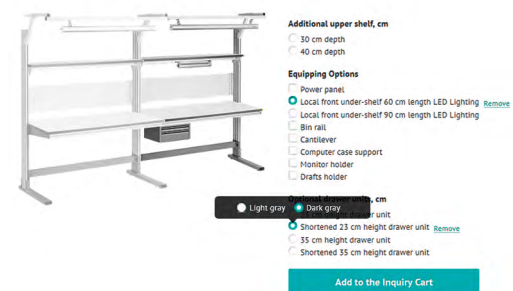

3D ONLINE WORKSPACE PLANNER

The 3D online workspace planner software is used for manufacturing space retrofitting planning, design and visualization; it provides the possibility of trying on several options of the entire production area equipment with VIKING furniture and additional elements.

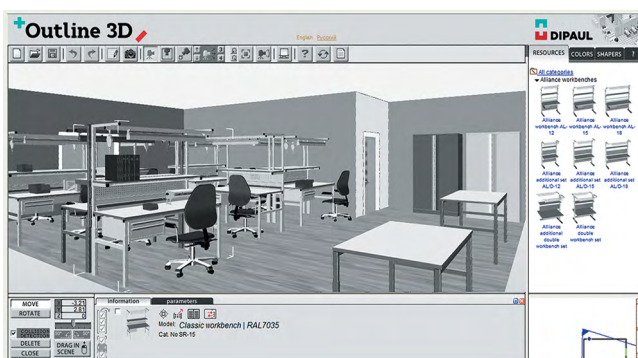
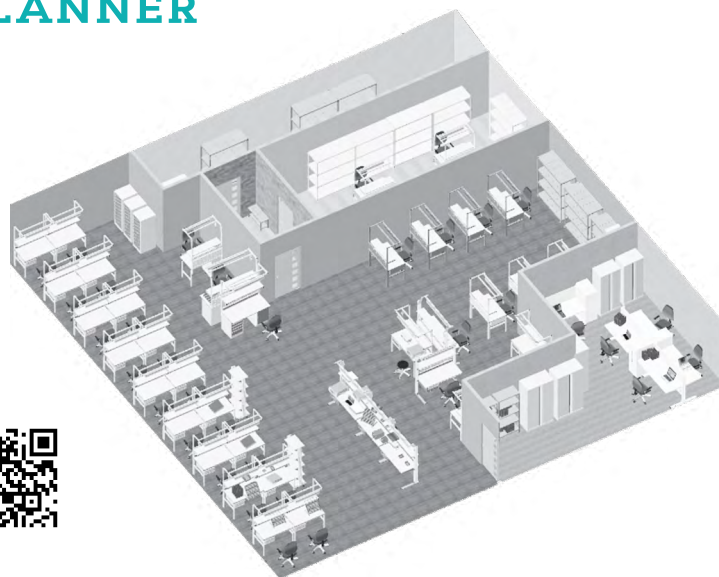

While being on the stage of planning new manufacturing facilities, workspace refurbishing or re-equipping it is very useful to have the ability to compare different types of furniture and equipment layouts. Using the exact halls dimensions, 3D Planner software user can build up a 3D plan of the hall, estimate the quantity of necessary technical furniture and it's disposition, arrange workplaces, passageways and utility premises. Our online 3D workspace Planner allows to specify windows, doors, columns' sizes and positions, and to choose colors and shapes of additional elements.

Online software is free for any visitor of <https://viking-esd.com>, one just needs to install a plug-in to their device.

Using 3D workspace planner software its user gets a visual plan of re-equipped halls in isometric, top and 3D front view and detailed list of chosen furniture and equipment. All images can be saved in standard .jpg format to be sent, viewed or printed or in specific .o3d format to continue the work later.

OUR CUSTOMERS





More pictures at <https://viking-esd.com/branches>

TECHNICAL&ESD FURNITURE

ALPHA, ALPHA universal



ALLIANCE, ALLIANCE automatic



GAMMA



CLASSIC



COMFORT



CONSTANT



OSTROV



VERSTAK



TITAN



Wire harness workbench



SPECIALIZED



UNIVERSAL



VIKING WORKPLACES SERIES

Most of VIKING products are available in technical and ESD (antistatic) versions, the latter are marked with ESD [label](#).

Steel frames are powder-coated in dark grey (RAL 7012) or light grey (RAL 7035) color, tabletops are resistant to abrasion. Some VIKING workbenches also have black (RAL 9005), white (RAL 9010) and turquoise (RAL 5021) parts. VIKING workbenches are modular, allowing customers to order only necessary parts and get workplaces for any specific [use](#).

Viking workbenches can be equipped with standard and LED upper workbench lighting [units](#).

Sets of furniture can be supplemented by additional equipment at any time after the purchase. Assembly and installation is quick and simple, clear assembly instructions are provided with each module, they are also available for download from <https://viking-esd.com>. VIKING ESD-protected products are compliant with IEC 61340 standard, have corresponding certificates and test [reports](#).

VIKING workbenches product range includes a wide line of functional, convertible and interchangeable modules for each particular enterprise. To facilitate configuration and simplify different elements choosing, our customers are welcome to use CONFIGURATOR (<https://viking-esd.com/constructor>), our online service that helps to interactively select all necessary workbench parts. After choosing required options and elements, one can print the individual set and use the picture and the list of modules for future [orders](#).



We divide our workbenches and supplementary elements in several series, each has its own peculiarities:

- **ALPHA** series workbenches allow effective use of space, offer practical structures and a compact size;
- **ALPHA Universal and ALPHA T** are simplified ALPHA workbenches without possibility of upper extensions;
- **ALLIANCE** workbenches are distinguished by elegant design, advanced ergonomics and convenient system of height adjustment. They can be placed in an inseparable line where each two tabletops are held by lateral frames and share those in the middle. Also available in double-sided version;
- **ALLIANCE Automatic** with motorized worktop adjustment system, performed by electric drive and simple control unit;
- **GAMMA SERIES** is based on the concept of clear surfaces, where all technical communications are hidden and the fasteners organically fit the design;
- **CLASSIC** workplaces are simple, functional and inexpensive. They can be placed in a line with no gaps for conveyor work;
- **COMFORT** workbenches are based on L-shape steel supports and offer advanced ergonomics for comfortable work;
- **CONSTANT** workbenches with fixed worktop height are equipped with functional supports and can withstand an increased load;
- **OSTROV** double-sided workbenches are designed for the most effective use of workspace;
- **VERSTAK** workbenches are available only in non-antistatic version, but their rigidity and different tabletop and support types will be useful for manufacturing process;
- **TITAN** heavy duty workbenches with up to 2000 kg load capacity and enhanced tabletops;
- **Wire harness workbench** with 0° to 80° angle adjustable worktop, which allows fastening various types of wires and bundles;
- **SPECIALIZED** workbenches were made to satisfy specific working process requirements;
- **UNIVERSAL** workbenches, the simplest and cheapest ones, they do not allow any above tabletop extensions.

In addition, we can always manufacture customized products and are confident of our ability to satisfy and meet our customer's individual requirements.

ALPHA SERIES WORKBENCHES



ALPHA series workbenches with lateral aluminum frames are stylish and ergonomic workbenches that can perfectly equip unspecified technical premises and educational facilities. Alpha series workbenches are distinguished by practical modular construction and compact size; they allow effective use of hall space. We offer four models of ALPHA series workbenches: single workbench, double workbench, simplified universal workbench, T-shape simplified workbench.









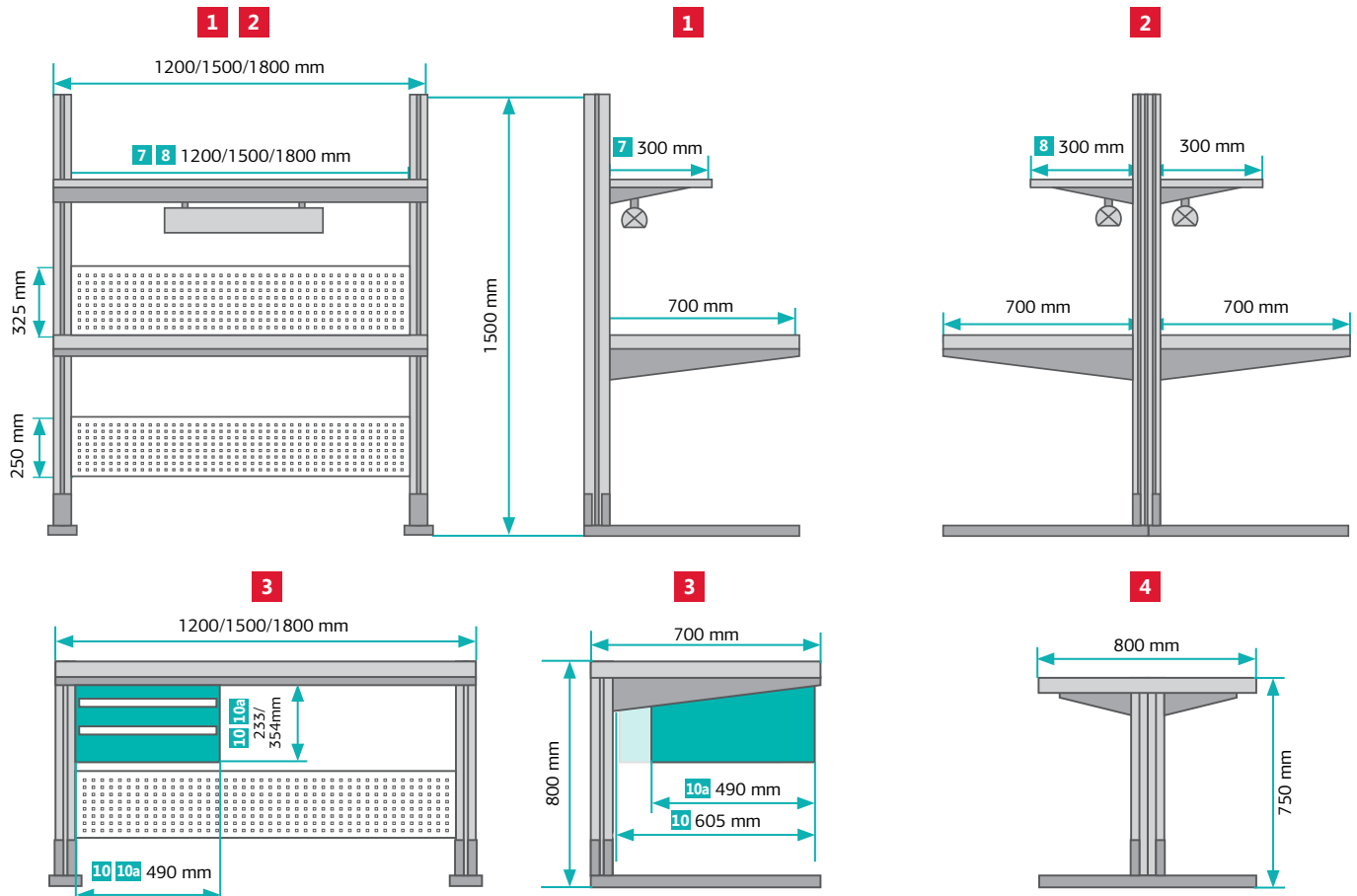

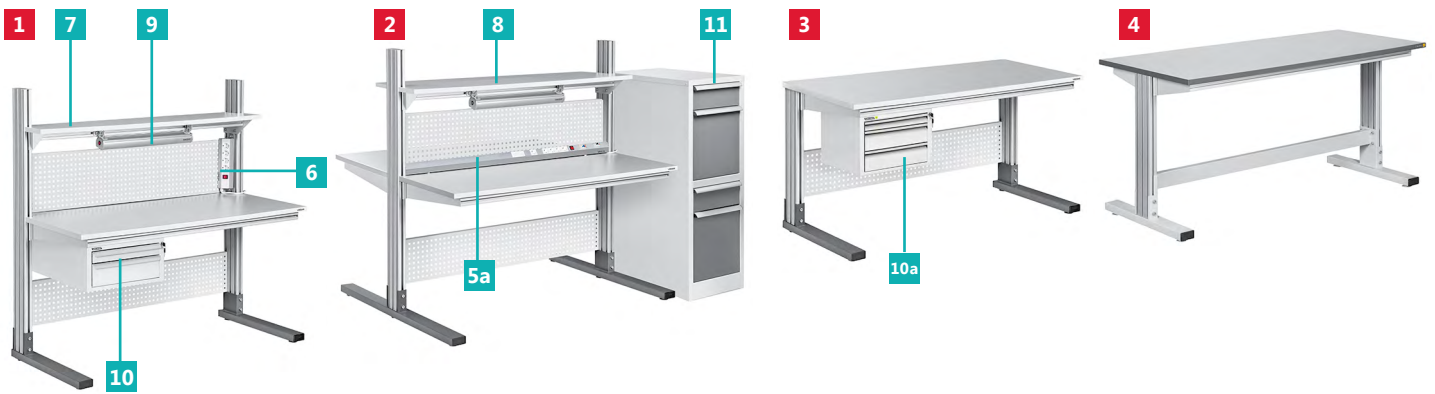













































All ALPHA series workbenches are bicolored by default. When ordering, please mention whether ESD or technical version required.







For this catalog legend, please see p. 73





- 1** 1 ALF Single workbench   
Single workbench with lateral aluminum frames is supplied in a set with two perforated panels.
 600-1100 mm
 200 kg  300 °C
- 2** ALF-O Double workbench   
Double-sided workbench with lateral aluminum frames is supplied in a set with two double perforated panels and two tabletops.
 600-1100 mm  per tabletop 200 kg
 300 °C
- 3** ALF-U Alpha universal workbench   
Simplified Alpha series workbench without upper modules.
 See more on p. 32.
- 4** ALF-T ALPHA T-shaped workbench   
Simplified Alpha series T-shaped workbench without the possibility of additional extensions.
 200 kg  300 °C
- 5** ALF-EPA Power panel /  
5a ALF-O-EPA Double power panel  
An aluminum case/ two cases with four sockets, protective contact, switch and 3 m cable. Can be equipped with additional sockets, fuses, phone jacks and earth leakage circuit breakers.
- Nominal load capacity: 10 A
- 6** ALF-EPA/B Side power panel  
Four sockets with protective contact and 3 m cable in a small aluminum case. Side power panel can be mounted on any part of lateral aluminum frame. No extension is possible.
- 7** ALF-PO Main shelf   
Main shelf for Alpha series single workbenches.
 1200-1500 mm
 50 kg
- 8** ALF-O-PO Double main shelf   
Main shelf for Alpha series double workbenches.
 1200-1500 mm
 each side 50 kg
- 9** DL/N Under-shelf local LED lighting  
Additional lighting can be mounted under the main shelf or attached to perforated panel. Suitable for any workbench equipped with upper modules. Angle adjustment 80°.
- 2 versions: 60 cm length and 90 cm length
- Luminous flux: 3150/4725 Lm
- Color temperature 4700–5300 K
Provides at least 1000-lux illuminance at 1000 mm distance from the light source.
- 10** Optional drawer units/    
10a Optional drawer units with reduced depth    
Storage solution for tools and components, no place on floor required. Those with reduced to 490 mm depth allow installing various additional equipment under a tabletop.
- 11** ALF-TMB-02 cabinet  
Spacious metal cabinet for documents, folders and personal belongings; can be attached to a workbench by bolts. Cabinet is equipped with two standard drawers and two sliding shelves with perforated sidewall, which can be placed on right or left side depending on further usage
 of a cabinet 445×1285×700 mm
 of a drawer 350×130×520 mm
 of a sliding shelf 350×355×610 mm
 30 kg
Available only in technical version.

Additional equipment for ALF-TMB-02 cabinet

- D-7/ALF-02 Horizontal dividers**  
Seven horizontal 335 mm length dividers help to organize cells for different small items.
- D-4/ALF-02 Vertical dividers**  
Four vertical 240×290 mm dividers help to organize slots for folders and documents.
 See more on p. 44.

ALLIANCE SERIES WORKBENCHES



ALLIANCE workbenches are distinguished by elegant design, advanced ergonomics and convenient system of height adjustment.

We also offer motorized worktop adjustment materialised in Alliance Automatic series workbenches AL-A.  See more on p. 15.

Several Alliance workbenches can be placed in an inseparable line where two tabletops are held by side lateral frames and share those in the middle.

Standard Alliance workbenches are powder-coated in dark grey color (RAL 7012) for lower steel modules and light grey color (RAL 7035) for tabletops and shelves. Possible tabletop height adjustment: 600–1300 mm. Possible lighting height adjustment: 1200–2000 mm.

All ALLIANCE series workbenches are bicolored by default. When ordering, please mention whether ESD or technical version required.

For this catalog legend, please see p. 73

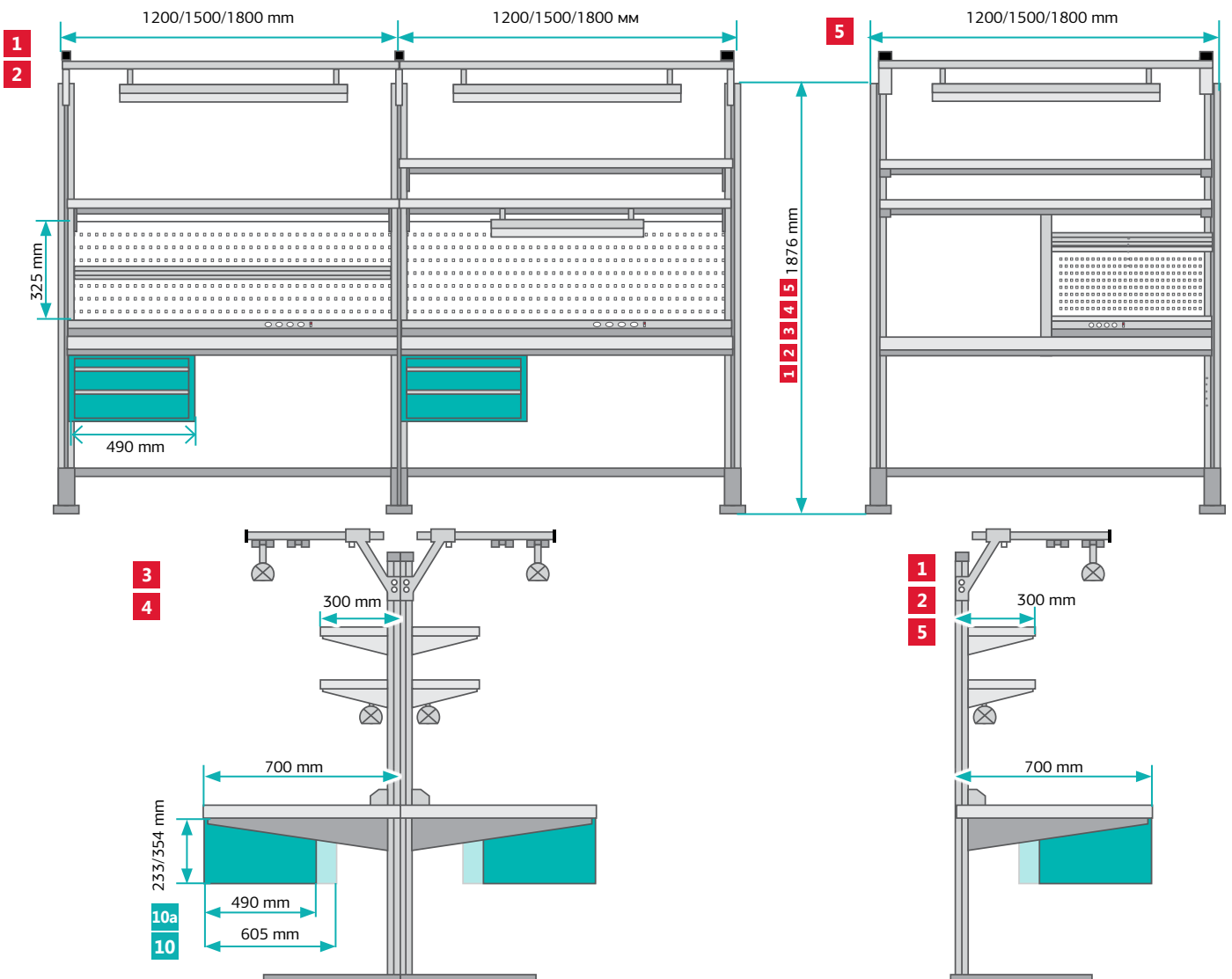

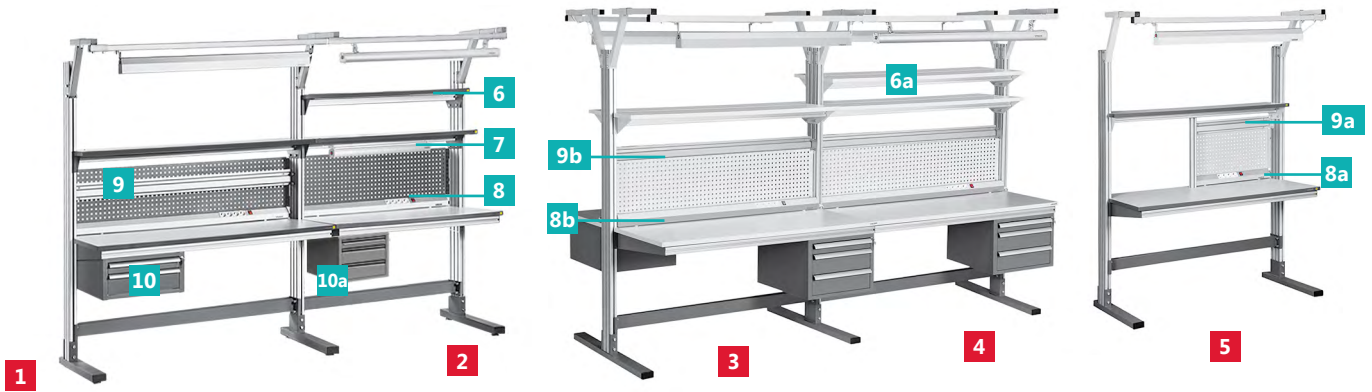

- 1

AL Alliance set/AL-S Alliance set with LED lamp

Single workbench with two lateral aluminum frames. The workbench is supplied in a set with lower slat, perforated panel, main shelf and lighting. AL-S Alliance sets are supplied with upper LED lighting.

200 kg
- 2

AL/D Alliance additional set / AL/D-S Alliance additional set with LED lamp

Additional set with one lateral aluminum frame is meant to be attached to main Alliance workbench from either side, which provides inseparable working surface line. The set includes: workbench with one lateral frame, lower slat, perforated panel, main shelf and lighting. AL/D-S Alliance additional sets are supplied with upper LED lighting.

200 kg
- 3

AL-O Alliance double set / AL-O-S Alliance double set with LED lamp

Double side workbench with two lateral aluminum frames. The workbench is supplied in a set with double lower cleat, double-sided perforated panel, double main shelf and two lighting units. AL-O-S Alliance double sets are supplied with two upper LED lighting units. each tabletop

200 kg
- 4

AL-O/D Alliance additional double set / AL-O/D-S Alliance additional double set with LED lamp

Double side workbench with one lateral aluminum frame to be attached to main Alliance double workbench. The workbench is supplied in a set with double lower slat, double-sided perforated panel, double main shelf and two lighting units. AL-O-S Alliance additional double sets are supplied with two upper LED lighting units.

each tabletop 200 kg
- 5

AL-SRST Alliance set/AL-SRST-S Alliance set with LED lamp

Single workbench with two lateral aluminum frames. The workbench is supplied in a set with middle upright, half-size perforated panel, lower slat, main shelf and lighting. AL-SRST-S Alliance sets are supplied with upper LED lighting.

each tabletop 200 kg
- 6

AL-PO/1 Additional shelf /
- 6a

AL-O-PO/1 Additional double shelf

1000-1850 mm 100 kg
- 7

DL/N Under-shelf local LED lighting

Additional lighting can be mounted under the main shelf or attached to perforated panel. Suitable for any workbench equipped with upper modules. Angle adjustment 80°

 - 2 versions: 60 cm length and 90 cm length.
 - Luminous flux: 3150/4725 Lm
 - Color temperature 4700-5300 K

Provides at least 1000-lux illuminance at 1000 mm distance from the light source.
- 8

AL-EP Power panel
- 8a

½ AL-EP Power panel
- 8b

AL-O-EP Double power panel

An aluminum case/ two cases with four sockets, protective contact, switch and 3 m cable. Can be equipped with additional sockets, fuses, phone jacks and earth leakage circuit breakers.

 - Nominal load capacity: 10 A
- 9

AL-RK Bin rail
- 9a

½ AL-RK Bin rail
- 9b

AL-O-RK Double bin rail

Aluminum rail for bin storage placed along workbench length.

 - AL-RK 1200/1500/1800×95 mm 10 kg
 - ½ AL-RK 560/710/860×95 mm
 - AL-O-RK 2*(1200/1500/1800)×95 mm
- 10

Optional drawer units/
- 10

Optional drawer units with reduced depth

Storage solution for tools and components, no place on floor required. Those with reduced to 490 mm depth allows installing various additional equipment under a tabletop.
- 11

AL-IP Cantilever

It was designed for easy-to-reach attaching of drawings, lighting and instruments. IP Cantilever can be additionally equipped by retracting KL-1200 mechanism.

ALLIANCE AUTOMATIC WORKBENCHES



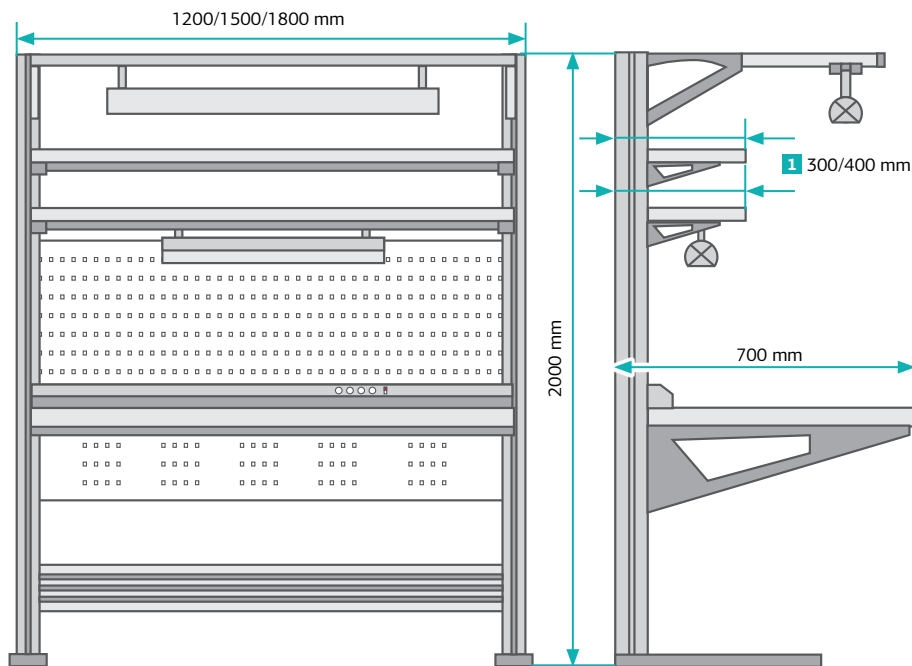

 For this catalog legend, please see p. 73



Alliance automatic workbenches AL/A are distinguished by elegant design, advanced ergonomics and motorized worktop adjustment system, performed by electric drive and simple control unit. ALLIANCE Automatic allows setting tabletop height easily and quickly by simply pressing a button, which is indispensable in certain working processes.



Alliance automatic workbenches are supplied in a set with adjustment mechanism, lower slat, perforated panel, main shelf, LED lighting and power panel.

-  700-950 mm
-  200 kg

Alliance automatic workbenches allow further extensions:

1 AL-A-PO/1 Additional shelf 

-  1050-1820 mm
-  100 kg

2 DL/N Under-shelf local lighting 

- Additional lighting can be mounted under the main shelf or attached to perforated panel. Suitable for any workbench equipped with upper modules. Angle adjustment 80°
- 2 versions: 60 cm length and 90 cm length
 - Luminous flux: 3150/4725 Lm
 - Color temperature 4700-5300 K

Provides at least 1000-lux illuminance at 1000 mm distance from the light source.

All ALLIANCE AUTOMATIC series workbenches and shelves are bicolored by default. When ordering, please mention whether ESD or technical version required

GAMMA SERIES WORKBENCHES

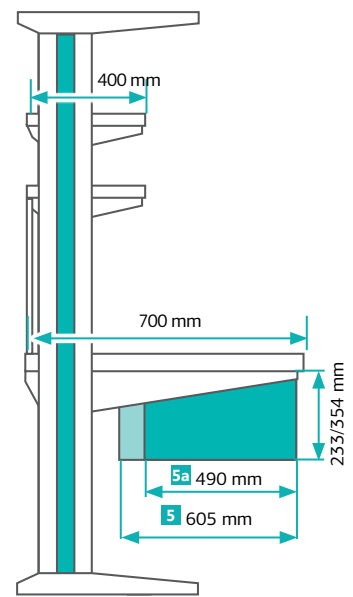
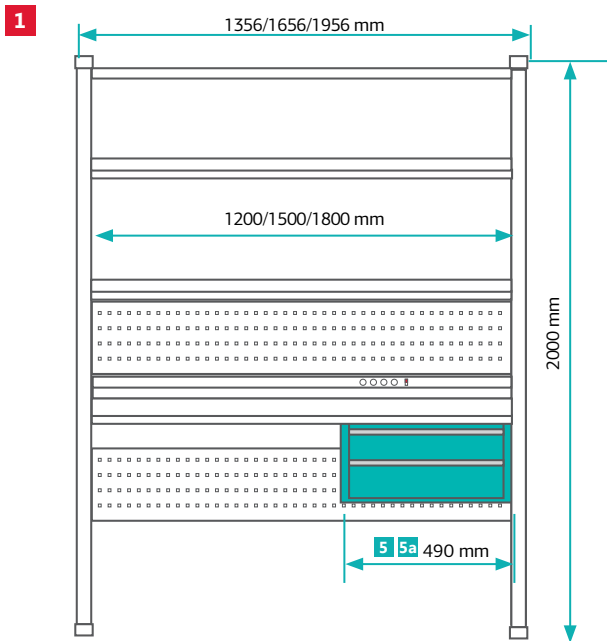

 For this catalog legend, please see p. 73

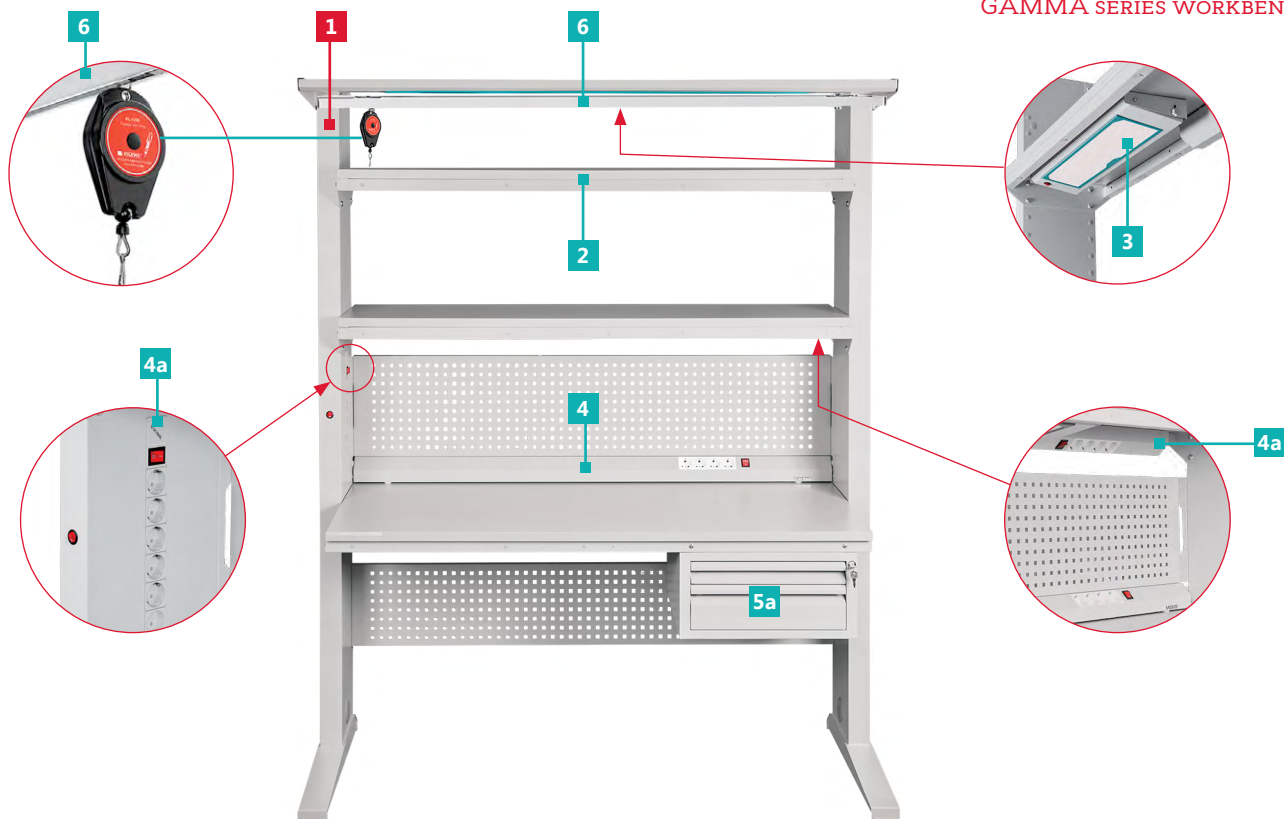

GAMMA SERIES workbenches are based on the concept of clear surfaces, where all technical communications are hidden and the fasteners are organically fit the design.

All horizontal surfaces of the workbench are mounted to L shape supports, which mask built-in technical communications, electrical and lighting connections and all necessary fixture, keeping the workspace clear.

- 1

GM GAMMA Workbench

The workbench is supplied in a set: workbench with L shape side supports, main shelf, upper LED lighting, upper and lower perforated panels and side built-in power panel.

Available in two versions, depending on the location of built-in power panel: with the right (PR in coding, for example GM-18/PR) or the left (L in coding, for example GM-12/L) power unit in the side panel. The built-in power panel is equipped with 6 sockets (5 with grounding and one without grounding) and a switch button.

Upper LED lighting is built into the top horizontal hanger above the tabletop.

 - Color temperature 3950-4000 K
 - Luminous flux: 4490 Lm
 - Power consumption: 38 W

Provides at least 1260-lux illuminance at 1000 mm distance from the light source.

All technical communications are easily accessible by opening the board in side supports.

for tabletop up to 200 kg

for shelf up to 200 kg
- 2

GM-PO/1 Additional shelf

1330-1870 mm with a 60 mm pitch

400 mm
- 3

GM-DL-6 GAMMA Under-shelf LED Lighting

Angle adjustment - 10°.

748x50x177 mm
- 4

GM-EPA Power panel
- 4a

½ GM-EPA Half-size Power panel

Half-size Power panel can be mounted below the main shelf or under the tabletop,

GM-EPA Power panel main panel can be mounted on the tabletop with the front side to and fro.

An aluminum case/ two cases with four sockets, protective contact, switch and 3 m cable. Can be equipped with additional sockets, fuses, phone jacks and earth leakage circuit breakers.

 - Nominal load capacity: 10 A.
- 5

Optional drawer units/
- 5a

Optional drawer units with reduced depth

Storage solution for tools and components, no place on floor required. Those with reduced to 490 mm depth allow installing various additional equipment under a tabletop.
- 6

GM-IP Cantilever

It was designed for easy-to-reach attaching of drawings, lighting and instruments. GM-IP Cantilever can be additionally equipped by retracting KL-1200 mechanism.

GAMMA workbenches are bicolored by default; the main color is light gray RAL 7035, additional – turquoise RAL 5021.

Technical version workbenches are supplied with gray (RAL 7035) edges, in antistatic version - with turquoise (RAL 5021) edges.

CLASSIC series workbenches





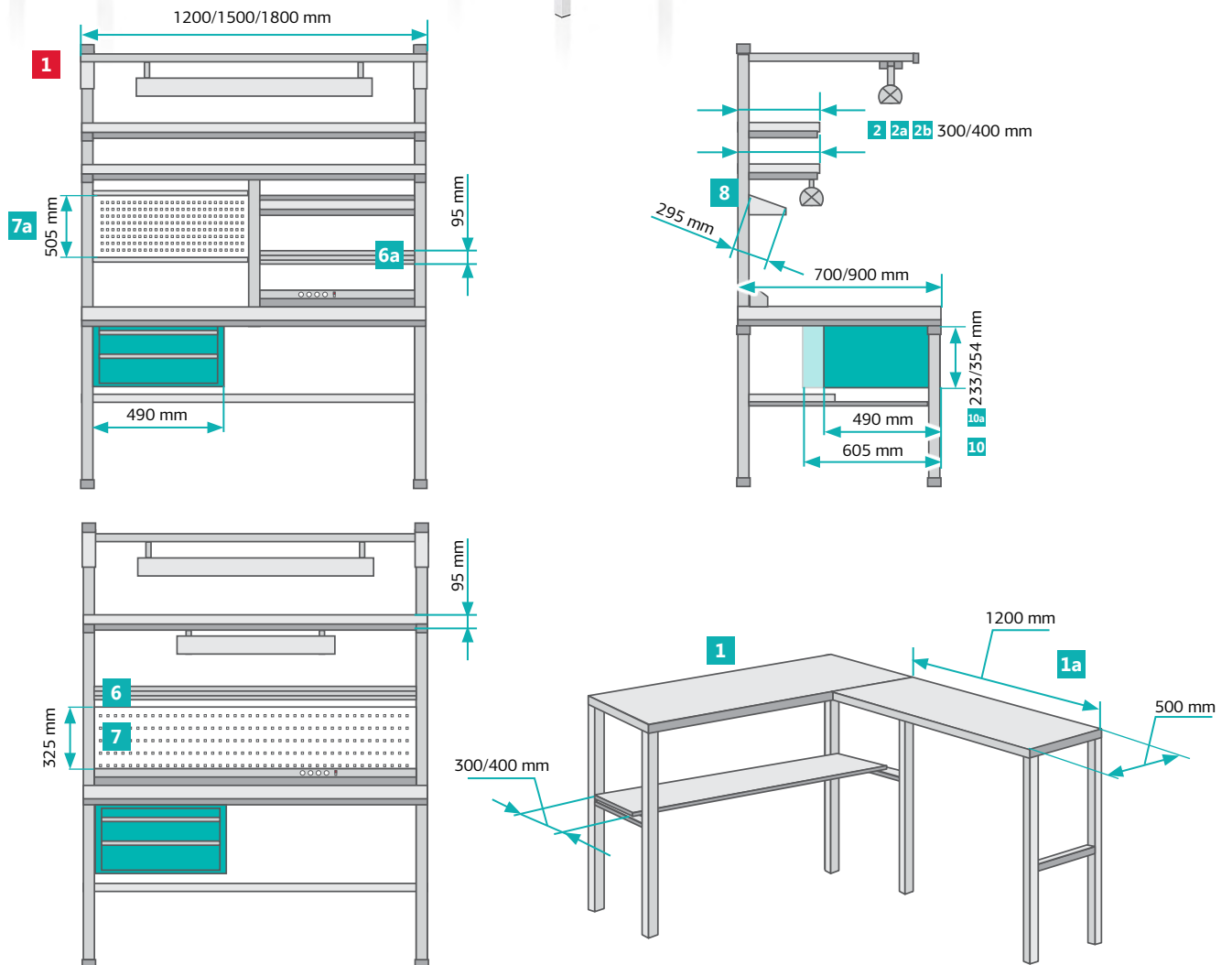

When ordering, please mention whether ESD or technical version, and whether dark grey RAL 7012 or light grey RAL 7035 color required.

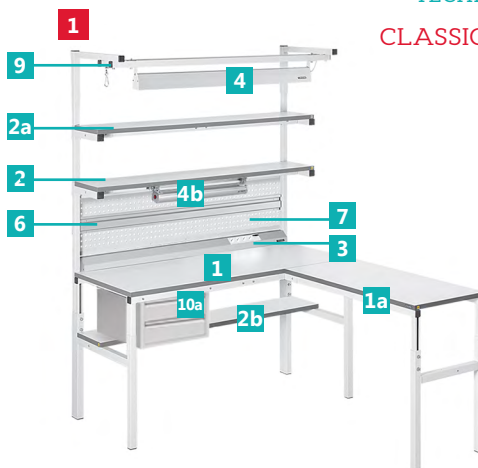
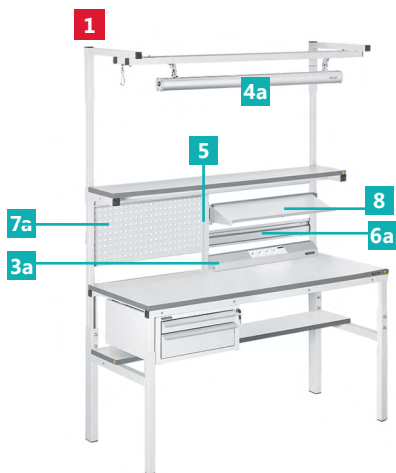

For this catalog legend, please see p. 73









1 SR Classic Workbench    





These workbenches can be placed in a line to make a common working area with no gaps. Universal design allows fitting out the workplace with additional equipment and drawer units.

 650–950 mm  300 kg



 300°C

1a US-1 Corner workbench    





Additional side outlier for Classic workbenches.

2 PO Main shelf    



Rear racks included.

 1000–1800 mm  50 kg





 300/400 mm

2a PO/1 Additional shelf    

Requires PO Main shelf to be installed. Rear racks excluded.



 1000–1800 mm  50 kg



 300/400 mm

2b PO/2 Underneath shelf    

Not compatible with TP-01/P and TP-10/P Optional drawer units.



 50 kg  300/400 mm

3 EP Power panel  

3a ½ EP Power panel  

An aluminum case/ half-size case with four sockets, protective contact, switch and 3 m cable. Can be equipped with additional sockets, fuses, phone jacks and earth leakage circuit breakers.



- Nominal load capacity: 10 A

4 DL/A Workbench lighting  

An aluminum case with two energy-efficient luminescent 54 W lamps, light direction regulation and shadowless reflector provided. Quick switching on without shimmering, no strobing freeze.

Provides at least 1200-lux illuminance at 1000 mm distance from the light source.

 from tabletop level 500–1350 mm

4a DL/S Workbench LED lighting  

An aluminum case with LED lamp and light direction regulation.

Color temperature 4700–5300 K

Luminous flux: 5985 Lm

Power consumption: 43 W

Provides at least 1200-lux illuminance at 1000 mm distance from the light source.

 from tabletop level 500–1350 mm

4b DL/N Under-shelf local lighting  



Additional lighting can be mounted under the main shelf or attached to perforated panel. Suitable for any workbench equipped with upper modules. Angle adjustment $\pm 60^\circ$

- 2 versions: 60 cm length and 90 cm length



- Luminous flux: 3150/4725 Lm



- Color temperature 4700–5300 K

Provides at least 1000-lux illuminance at 1000 mm distance from the light source.



5 Middle upright for all items   

Required to hold any ½ item. Three sizes to match standard workbench width.



6 RK Bin rail   



6a ½ RK Bin rail   

Aluminum rail for bin storage placed along workbench length.



 RK — 1200/1500/1800×95 mm  10 kg

 ½RK — 560/710/860×95 mm





7 PFP Perforated panel   

7a ½ PFP Perforated panel   



Panel can be equipped with different holders for additional equipment and tools storage —  See more on p.41



 PFP- 1190/1490/1790×325 mm  10 kg

 ½PFP - 610/760/910×505 mm





8 8 PN Sloped shelf    





Half-sized shelf. 10–55° angle adjustment provides comfort monitoring of working equipment.

 534/684/834×295 mm  50 kg

9 IP Cantilever   

Upper slat for fastening drawings, additional lighting and instruments. IP Cantilever can be additionally equipped by retracting KL-1200 mechanism —  See more on p.38

10 Optional drawer units/    

10a Optional drawer units with reduced depth    

Storage solution for tools and components, no place on floor required. Those with reduced to 490 mm depth allow installing various additional equipment under a tabletop.

COMFORT SERIES WORKBENCHES



When ordering, please mention whether ESD or technical version, and whether dark grey RAL 7012 or light grey RAL 7035 color required.

For this catalog legend, please see p. 73

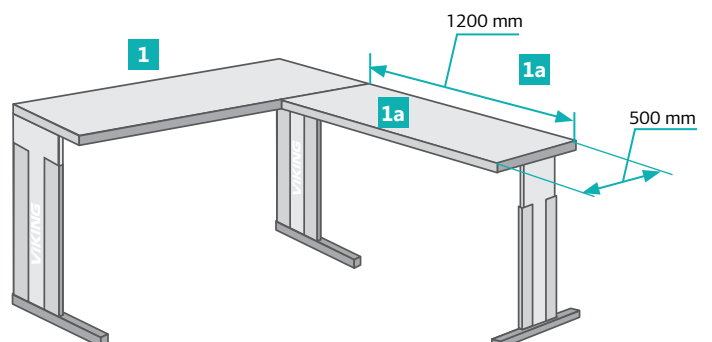
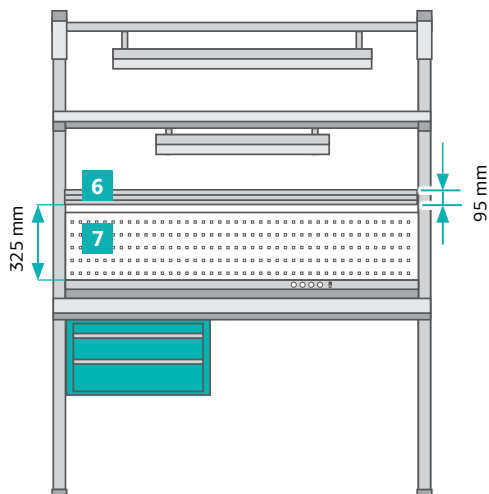
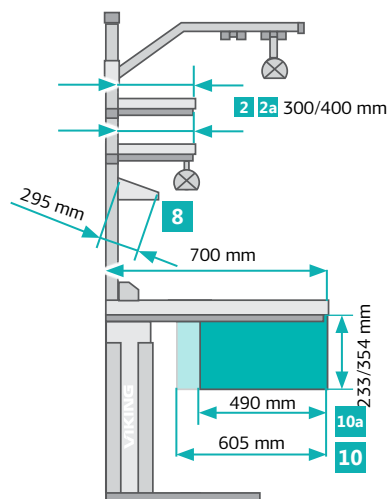
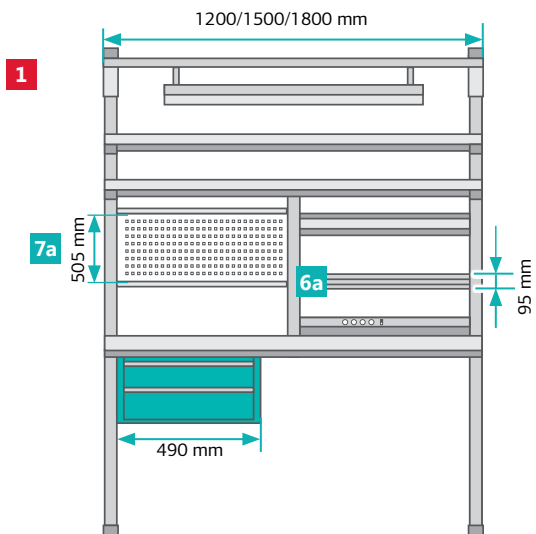

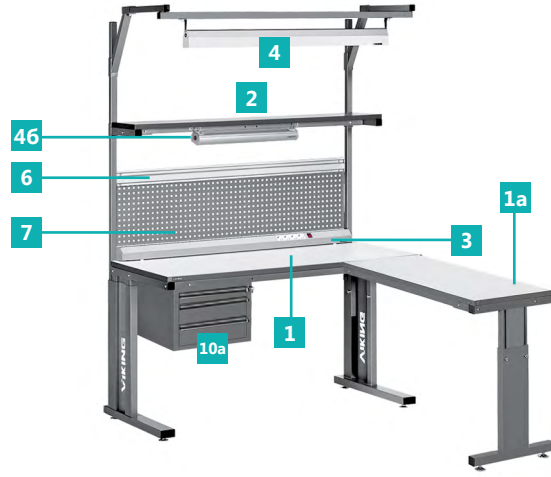
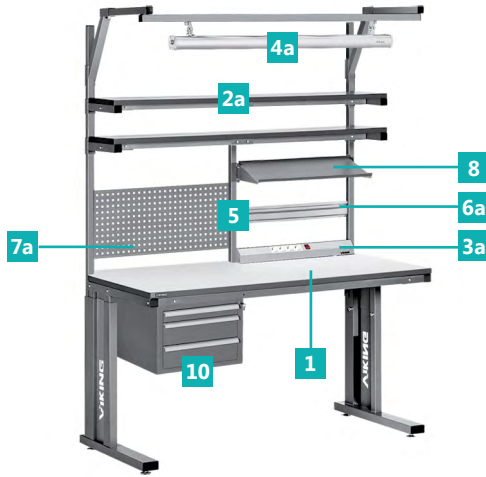

- 1

SR COMFORT Workbench

Workbenches are settled on L-shape side supports and can be additionally equipped with a number of applicative modules.

800–950 mm

200 kg

300°C
- 1a

US-1 Comfort Corner workbench

Additional side outlier for Comfort workbenches.
- 2

PO Main shelf

Rear racks included.

1000–1800 mm

50 kg

300/400 mm
- 2a

PO/1 Additional shelf

Requires PO Main shelf to be installed. Rear racks excluded.

1000–1800 mm

50 kg

300/400 mm
- 3

EP Power panel
- 3a

½ EP Power panel

An aluminum case/ half-size case with four sockets, protective contact, switch and 3 m cable. Can be equipped with additional sockets, fuses, phone jacks and earth leakage circuit breakers.

 - Nominal load capacity: 10 A
- 4

DL/A Comfort Workbench lighting

An aluminum case with two energy-efficient luminescent 54 W lamps, light direction regulation and shadowless reflector provided. Quick switching on without shimmering, no strobing freeze. Provides at least 1200-lux illuminance at 1000 mm distance from the light source.

from tabletop level 500–1350 mm
- 4a

DL/S Workbench LED lighting

An aluminum case with LED lamp and light direction regulation. Color temperature 4700-5300 K
Luminous flux: 5985 Lm
Power consumption: 43 W
Provides at least 1200-lux illuminance at 1000 mm distance from the light source.

from tabletop level 500–1350 mm
- 4b

DL/N Under-shelf local lighting

Additional lighting can be mounted under the main shelf or attached to perforated panel. Suitable for any workbench equipped with upper modules. Angle adjustment ±60°

- 2 versions: 60 cm length and 90 cm length
 - Luminous flux: 3150/4725 Lm
 - Color temperature 4700–5300 K

Provides at least 1000-lux illuminance at 1000 mm distance from the light source.
- 5

Middle upright for all items

Required to hold any ½ item. Three sizes to match standard workbench width.
- 6

RK Bin rail
- 6a

½ RK Bin rail

Aluminum rail for bin storage placed along workbench length.

RK — 1200/1500/1800×95 mm

10 kg

½ RK — 560/710/860×95 mm
- 7

PFP Perforated panel
- 7a

½ PFP Perforated panel

Panel can be equipped with different holders for additional equipment and tools storage.

10 kg

PFP — 1190/1490/1790×325 mm

½ PFP — 610/760/910×505 mm

[See more on p.41](#)
- 8

PN Sloped shelf

Half-sized shelf with 10-55° angle adjustment provides comfort monitoring of working equipment.

534/684/834×295 mm

50 kg
- 9

IP Cantilever

Upper slat for fastening drawings, additional lighting and instruments. IP Cantilever can be additionally equipped by retracting KL-1200 mechanism.

[See more on p.38](#)
- 10

Optional drawer units/
- 10a

Optional drawer units with reduced depth

Storage solution for tools and components, no place on floor required. Those with reduced to 490 mm depth allow installing various additional equipment under a tabletop.

CONSTANT SERIES WORKBENCHES





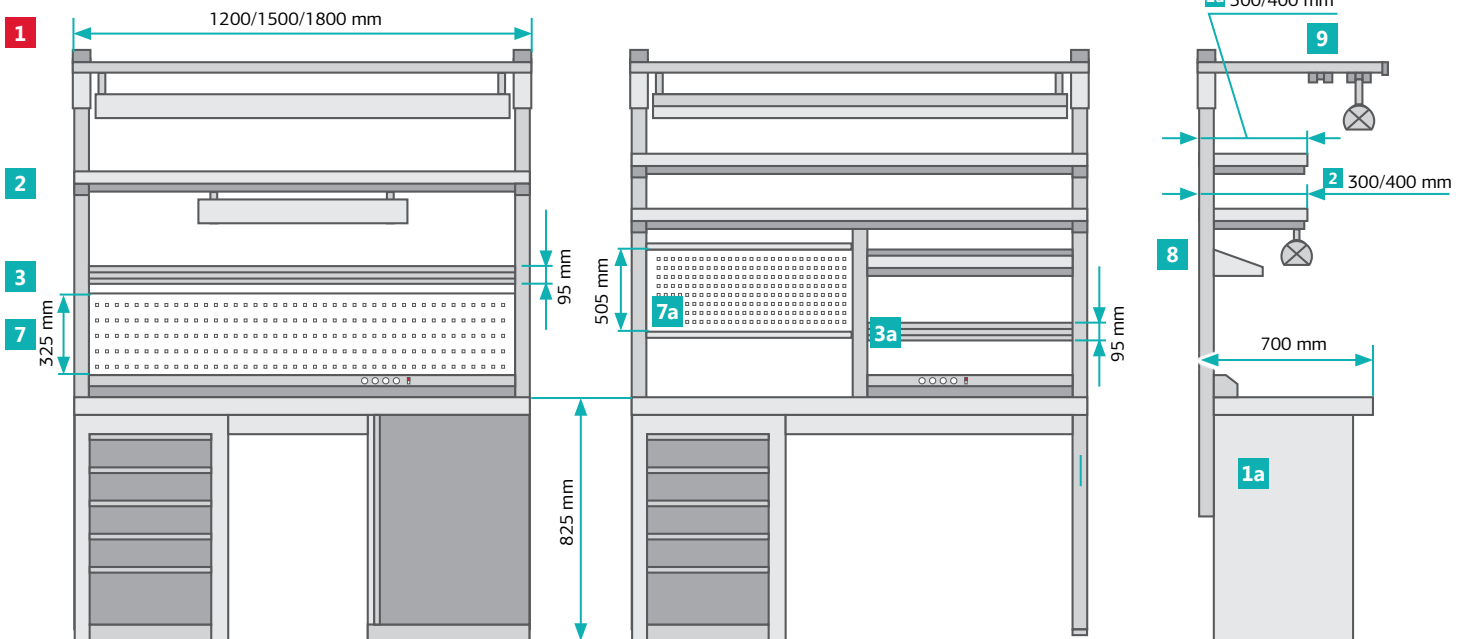

When ordering, please mention whether ESD or technical version required.

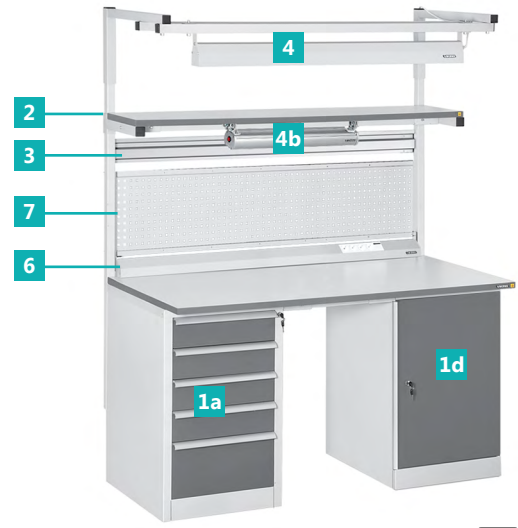
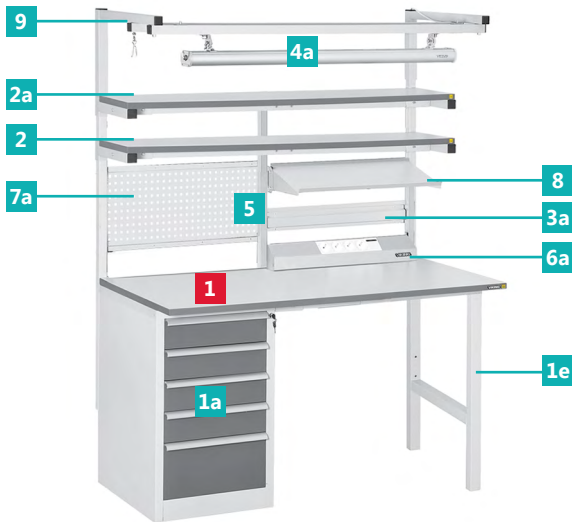
For this catalog legend, please see p. 73





1 SR CONSTANT workbenches   
 These workbenches cannot be height-adjusted.
 300 kg  300°C







As a support, CONSTANT workbenches can have:







- 1a** Cabinet unit with five drawers on telescopic runners and a lock (+DR-05 in code);
- 1b** Cabinet unit with three bigger drawers on telescopic runners and a lock (+DR-03 in code);
- 1c** Cabinet with two shelves and a lock (+ TMB-01 in code);
- 1d** Cabinet with one drawer and two shelves in a locked section (+ TMB-02 in code);
- 1e** Legs.

CONSTANT worktop supports can be used in any combination for 1500 mm and 1800 mm width workbenches. 1200 mm width workbenches should have legs as one support.





Workbench with legs and 5-drawers cabinet as supports has +DR-05 in code, for example 1200 mm width workbench ordering code is SR-12-7+DR-05.
 Workbench with 3-drawer cabinets and 2-shelves cabinet has +DR-03+TMB-01 in code, for example 1500 mm width workbench ordering code SR-15-7+DR-03+TMB-01.



Cabinets and drawer units used as worktop supports are bicolored by default.



2 PO Main shelf   
 Rear racks included.
 1000–1800 mm  50 kg  300/400 mm



2a PO/1 Additional shelf   
 Requires PO Main shelf to be installed. Rear racks excluded.
 1100–1800 mm  50 kg  300/400 mm



3 RK Bin rail  

3a ½ RK Bin rail  
 Aluminum rail for bin storage placed along workbench length.
 RK — 1200/1500/1800×95 mm  10 kg
 ½ RK — 560/710/860×95 mm



4 DL/A Workbench lighting  
 An aluminum case with two energy-efficient luminescent 54 W lamps, light direction regulation and shadowless reflector provided. Quick switching on without shimmering, no strobing freeze.
 Provides at least 1200-lux illuminance at 1000 mm distance from the light source.
 from tabletop level 500–1350 mm



4a DL/S Workbench LED lighting  
 An aluminum case with LED lamp and light direction regulation.
 Color temperature 4700–5300 K  from tabletop level 500–1000 mm
 Luminous flux: 5985 Lm
 Power consumption: 43 W
 Provides at least 1200-lux illuminance at 1000 mm distance from the light source.







4b DL/N Under-shelf local lighting  
 Additional lighting can be mounted under the main shelf or attached to perforated panel. Suitable for any workbench equipped with upper modules. Angle adjustment ±60°
 - 2 versions: 60 cm length and 90 cm length
 - Luminous flux: 3150/4725 Lm
 - Color temperature 4700–5300 K
 Provides at least 1000-lux illuminance at 1000 mm distance from the light source.





5 Middle upright for all items  
 Required to hold any ½ item. Three sizes to match standard workbench width.



6 EP Power panel  

6a ½ EP Power panel  
 An aluminum case/ half-size case with four sockets, protective contact, switch and 3 m cable. Can be equipped with additional sockets, fuses, phone jacks and earth leakage circuit breakers.
 - Nominal load capacity: 10 A

7 PFP Perforated panel  

7a ½ PFP Perforated panel  
 Panel can be equipped with different holders for additional equipment and tools storage.
 PFP — 1190/1490/1790×325 mm
 ½ PFP — 610/760/910×505 mm
 10 kg  See more on p.41

8 PN Sloped shelf   
 Half-sized shelf. 10–55° angle adjustment provides comfort monitoring of working equipment.
 50 kg  534/684/834×295 mm

9 IP Cantilever  
 Upper slat for fastening drawings, additional lighting and instruments. IP Cantilever can be additionally equipped by retracting KL-1200 mechanism  See more on p.38

OSTROV SERIES WORKBENCHES



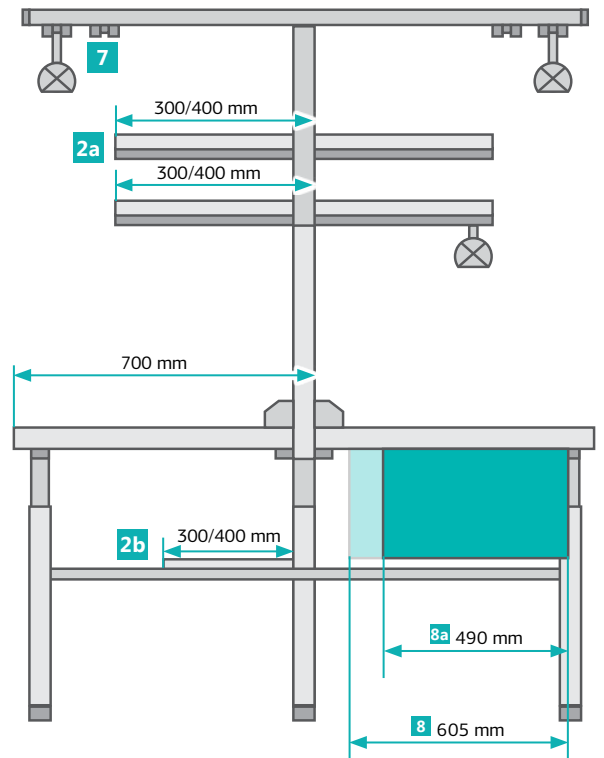
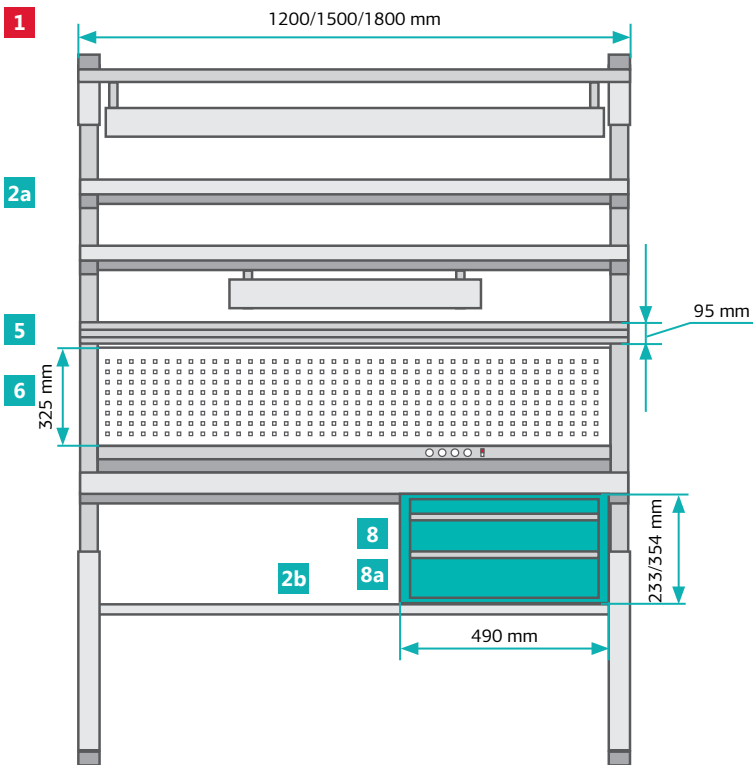

When ordering, please mention whether ESD or technical version, and whether dark grey RAL 7012 or light grey RAL 7035 color required.

For this catalog legend, please see p. 73

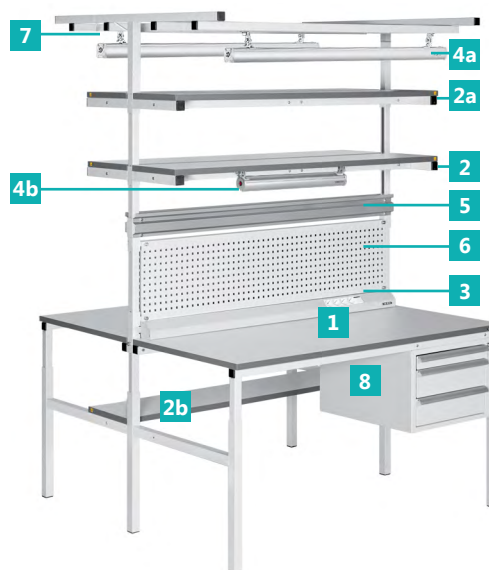



1 SO OSTROV Workbench   

Double-sided workbench allows effective use of space. Basic configuration includes Rear racks and 300 mm shelves for each side of the workstation.



 720–930 mm

 300°C  each side 300 kg

2a PO-O Additional shelf   



Should be mounted to Rear racks of the workbench

 1100–1800 mm

 300/400 mm  50 kg

2b PO/2 Underneath shelf   

Not compatible with TP-01/P and TP-10/P Optional drawer units.

 300/400 mm  50 kg

3 EP-O Double Power panel  

Two aluminum cases each with four sockets, protective contact, switch and 3 m cable. Can be equipped with additional sockets, fuses, phone jacks and earth leakage circuit breakers.



- Nominal load capacity: 10 A

4 DL-O/S Double Workbench LED lighting  

T-shape rack with two aluminum cases each with two energy-efficient luminescent 54 W lamps, light direction regulation and shadowless reflector provided. Quick switching on without shimmering, no strobing freeze.

Provides at least 1200-lux illuminance at 1000 mm distance from the light source.

 from tabletop level 500–1350 mm

4a DL-O/S Double Workbench LED lighting  

T-shape rack with two aluminum cases each with LED lamp and light direction regulation.



Color temperature 4700-5300 K

Luminous flux: 5985 Lm

Power consumption: 43 W

Provides at least 1200-lux illuminance at 1000 mm distance from the light source.

 from tabletop level 500–1350 mm

4b DL/N Under-shelf local lighting  



Additional lighting can be mounted under the main shelf or attached to perforated panel. Suitable for any workbench equipped with upper modules. Angle adjustment 80°

- 2 versions: 60 cm length and 90 cm length

- Luminous flux: 3150/4725 Lm

- Color temperature 4700–5300 K

Provides at least 1000-lux illuminance at 1000 mm distance from the light source.



5 RK-O Double bin rail  

Double aluminum rail for storage bins is placed along workbench length.

 10 kg



 See more on p.41.

 2*(1200/1500/1800)×95 mm



6 PFP-O Double perforated panel  



The panel can be equipped by different holders for additional equipment and tools storage.  See more on p.38.

 2*(1190/1490/1790)×325 mm

7 IP Cantilever  

Upper slat for fastening drawings, additional lighting and instruments. IP Cantilever can be additionally equipped by retracing KL-1200 mechanism.

8 Optional drawer units/   

8a Optional drawer units with reduced depth   

Storage solution for tools and components, no place on floor required. Those with reduced to 490 mm depth allow installing various additional equipment under a tabletop.

VERSTAK SERIES TECHNICAL WORKBENCHES

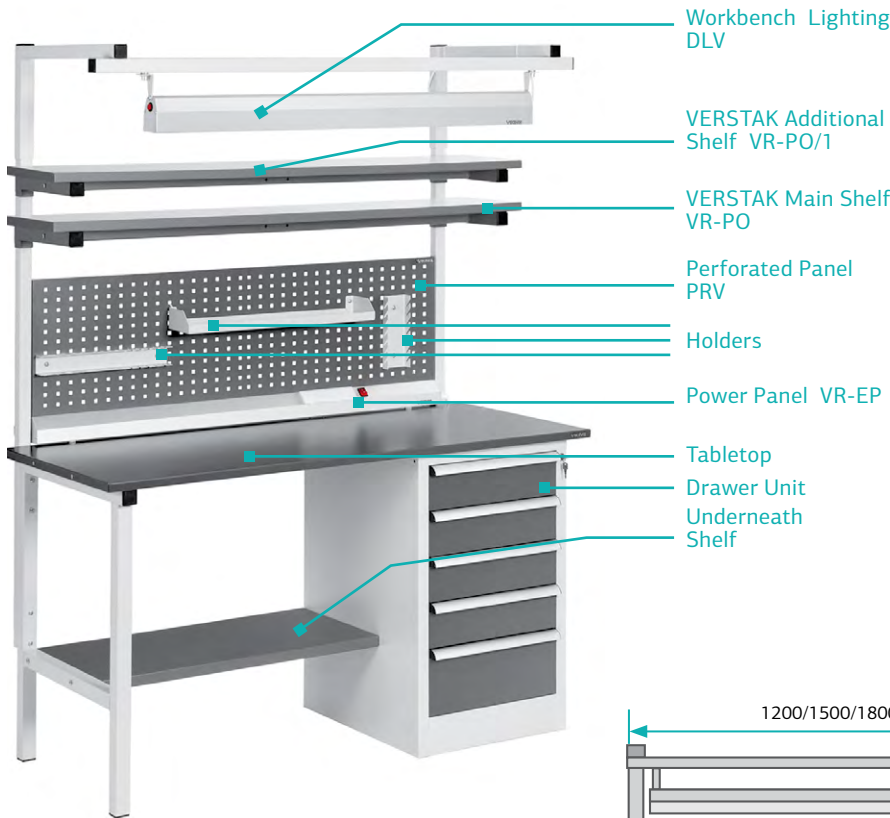

VERSTAK series offer module workbenches of heightened rigidity and durability with distributed load capacity of over 500 kg. These workbenches are only available in technical /non-antistatic version.



For this catalog legend, please see p. 73

Perforated panel PRV, Power panel VR-EPA and Workbench lighting DLV are mounted to Rear Racks that are supplied in a set with Main shelf or should be ordered separately if Main Shelf is not required. Perforated panel is supplied in a set with Small Rear Racks thus can be ordered separately from other upper modules..

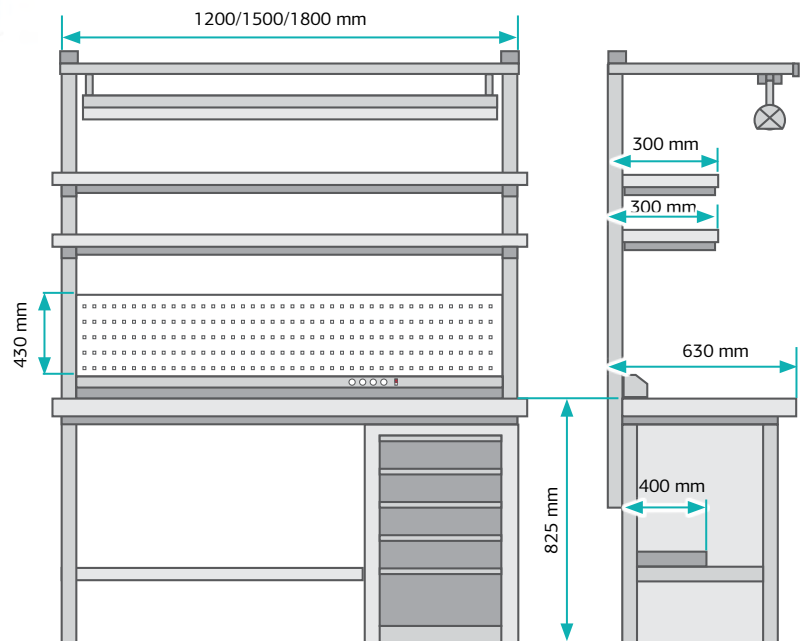

Maximum functionality is achieved by possibility of using a range of tabletops, supports and additional equipment.

There are 5 types of tabletops

- 1 21 mm thick plywood with light grey plastic edges.
- 2 21 mm thick plywood covered by 2 mm dark grey metal sheet, the latter is bent over edges.
- 3 21 mm thick plywood with light grey plastic edges covered by 6 mm dark grey metal sheet.
- 4 6 mm thick dark grey metal sheet.
- 5 Combined tabletop made of 21 mm thick plywood covered by 6 mm shockproof, resistant to abrasion and mechanical influences grey plastic with plastic edges.

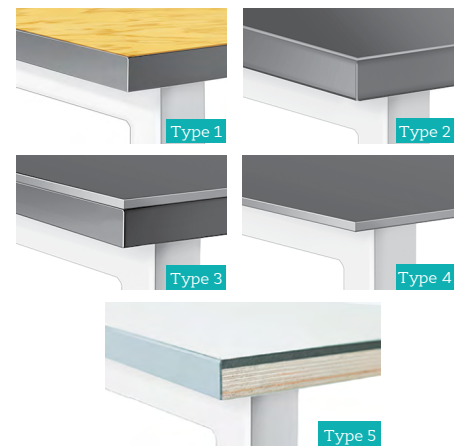

There are five standard types of worktop supports:

- 1a** Cabinet unit with five drawers on telescopic runners and a lock (+DR-05);
- 1b** Cabinet unit with three bigger drawers on telescopic runners and a lock (+DR-03);
- 1c** Cabinet with two shelves and a lock (+TMB-01);
- 1d** Cabinet with one drawer and two shelves in a locked section (+TMB-02);
- 1e** Legs.

These supports can be used in any combination, except for 1200 mm width VERSTAK workbenches that should have legs as one of the tabletop supports.

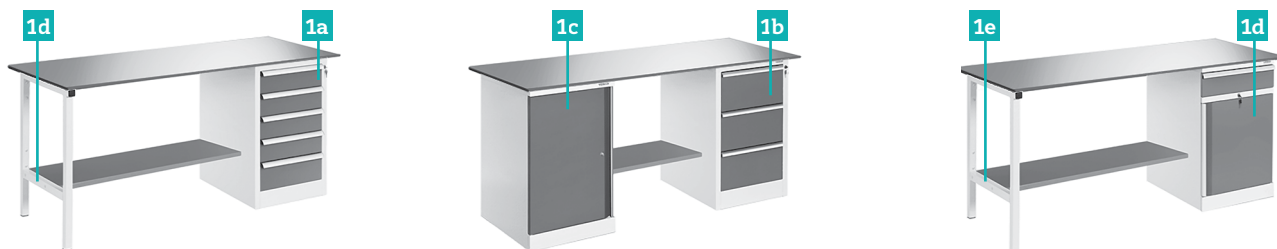

	VERSTAK with a drawer unit (DR-03 or DR-05)	VR-12+DR-03/No.	VR-12+DR-05/No.	1200×630 mm
		VR-15+DR-03/No.	VR-15+DR-05/No.	1500×630 mm
		VR-18+DR-03/No.	VR-18+DR-05/No.	1800×630 mm
	VERSTAK with a cabinet (TMB-01 or TMB-02)	VR-12+TMB-01/No.	VR-12+TMB-02/No.	1200×630 mm
		VR-15+TMB-01/No.	VR-15+TMB-02/No.	1500×630 mm
		VR-18+TMB-01/No.	VR-18+TMB-02/No.	1800×630 mm
	VERSTAK with different combinations of cabinets (TMB-01, TMB-02) and drawer units (DR-03, DR-05)	VR-15+DR-05+DR-05/No.	VR-15+DR-03+DR-03/No.	1500×630 mm
		VR-15+DR-03+DR-05/No.	VR-15+TMB-01+TMB-01/No.	
		VR-15+TMB-01+TMB-02/No.	VR-15+TMB-02+TMB-02/No.	
		VR-15+DR-05+TMB-01/No.	VR-15+DR-05+TMB-02/No.	1800×630 mm
		VR-15+DR-03+TMB-02/No.	VR-15+DR-03+TMB-01/No.	
		VR-18+DR-05+DR-05/No.	VR-18+DR-03+DR-03/No.	
VR-18+DR-03+DR-05/No.	VR-18+TMB-01+TMB-01/No.	1800×630 mm		
VR-18+TMB-01+TMB-02/No.	VR-18+TMB-02+TMB-02/No.			
VR-18+DR-05+TMB-01/No.	VR-18+DR-05+TMB-02/No.			
VR-18+DR-03+TMB-02/No.	VR-18+DR-03+TMB-01/No.			

Note: No. in the workbench code corresponds to tabletop type (1, 2, 3, 4 or 5). For example, VR-12+TMB-01/3.

PRV Perforated Panel for VERSTAK workbench (small shelf and 2 holders included).	PRV-12	for 1200 mm width workbenches
	PRV-15	for 1500 mm width workbenches
	PRV-18	for 1800 mm width workbenches
DLV Workbench Lighting. Requires Main shelf or Rear Racks to be installed.	DLV-12	for 1200 mm width workbenches
	DLV-15	for 1500 mm width workbenches
	DLV-18	for 1800 mm width workbenches
DLS VERSTAK LED Upper Workbench Lighting.	DLS-12	for 1200 mm width workbenches
	DLS-15	for 1500 mm width workbenches
	DLS-18	for 1800 mm width workbenches
VR-PO VERSTAK Main Shelf.	VR-PO-12	1200×300 mm
	VR-PO-15	1500×300 mm
	VR-PO-18	1800×300 mm
VR-PO/1 VERSTAK Additional Shelf. Requires Main shelf.	VR-PO/1-12	1200×300 mm
	VR-PO/1-15	1500×300 mm
	VR-PO/1-18	1800×300 mm
VR-EP: VERSTAK Power Panel. Requires Main shelf or Rear Racks or PRV.	VR-EP-12	for 1200 mm width workbenches
	VR-EP-15	for 1500 mm width workbenches
	VR-EP-18	for 1800 mm width workbenches
DL/N: Under-shelf local lighting. Requires Main shelf or PRV	DL/N-6	600 mm
	DL/N-9	900 mm
Rear Racks	KZS	1500 mm
Small Rear Racks	UKZS	900 mm

TITAN SERIES HEAVY DUTY TECHNICAL WORKBENCHES



Titan series technical furniture is designed for mechanical works, which require reinforced load capacities, especially in machine-building and metalworking industries, in workshops and car services.

Main features of Titan series furniture:

- 2000 kg load capacity for workbenches, reinforced runners for drawers and durable wheels for movable workstations and trolleys;
- Two types of shock resistant and high-abrasion tabletops; various sets of modules allow selecting an optimal variant;
- Demountable construction, which consists of four parts, provides convenience of transportation.

Two types of tabletops available for the workbench:



Default colors combination is RAL 5021 (turquoise), RAL 9005 (black) and RAL 9010 (white). Matte paint texture

30 mm thick plywood coated with 10 mm shockproof plastic

30 mm thick plywood coated with 6 mm sheet metal

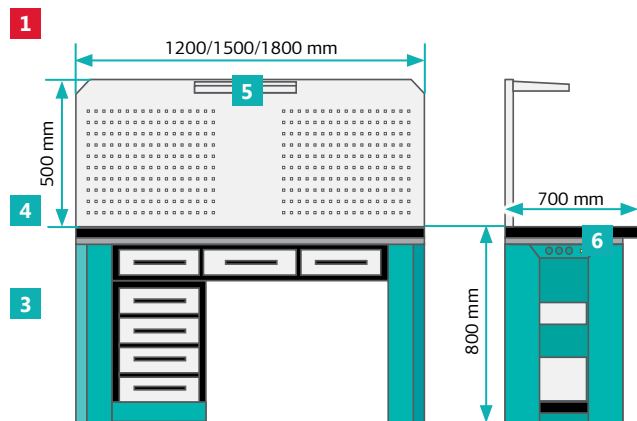

1

VT/B



For this catalog legend, please see p. 73

1 1 VT/R, VT/B TITAN Heavy-duty Workbench

TITAN heavy-duty workbench is a high tech construct that doesn't need any utility supports under the tabletop. All the stiffeners organically fit the design of the workbench.

Load capacity and rigidity are achieved through optimally calculated 1.5 mm thick structural iron profiles.

TITAN heavy-duty workbenches in basic version (VT/B) are supplied with technological plugs in a frame under the tabletop, heavy duty workbenches in expanded version (VT/R) are supplied with reinforced telescopic drawers:

- 2 small drawers 300×80×450 mm for 1200 wide mm workbenches
- 3 small drawers 300×80×450 mm for 1500 wide mm workbenches
- 2 small drawers 300×80×450 mm and 1 big drawer 640×80×450 mm for 1800 wide mm workbenches

Heavy-duty workbenches' weight is 160/180/200 kg depending on its size.

All heavy-duty workbenches are equipped with small side shelves under the tabletop.



2000 kg distributed



300 kg dynamic



80 kg per drawer

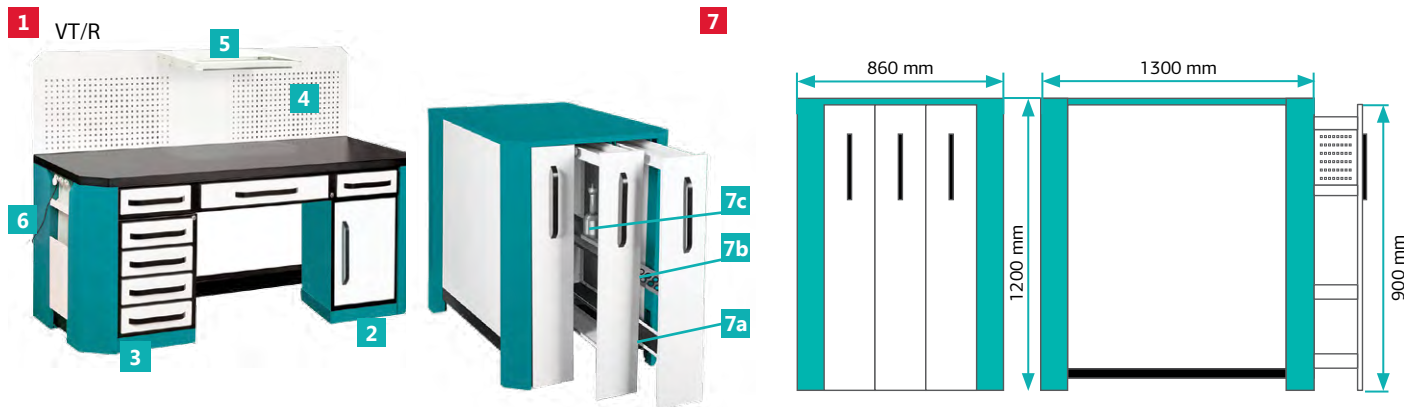



2 Attachable drawer unit with door TMB-01/VT

Drawer unit for tools and accessories storage is placed under the heavy duty workbench frame and is mounted by bolting if necessary. Drawer unit is equipped with a door and an inner shelf.

 390×610×570 mm  20 kg  80 kg per shelf

3 Attachable drawer unit with drawers DR-04/VT

Attachment drawer unit for tools and accessories storage is placed under the heavy workbench and is mounted by bolting if necessary. It is equipped with 4 drawers 300*80*450 mm with reinforced load characteristics.

 390×610×570 mm  30 kg
 80 kg per drawer

4 Perforated panel PFP/VT

It is designed for fastening additional equipment and tools; it can be equipped with K/VT series tools holders.

 30 kg

5 Hinged LED lamp DL/VT

Metal case with LED lamp is fastened in the central zone of the perforated panel.

- Illumination of the working surface at a distance of 1000 mm from the light source – at least 1000 lux for central zone.
- 10 ° angle adjustment provided.

 745×255×50 mm

6 Power panel EPA/VT

Trapezoidal power panel is installed under the tabletop of heavy-duty workbenches inside the lateral support. Power panel is equipped with three protected European socket outlets, power switch and three-meter cable network, which is output through the support of heavy workbench.

- Nominal load: 10 A
- Cross-section of grounding cable: 1.5 mm



7 Tools cabinet SHK/VT

Titan series reinforced tools cabinet can be used for milling, drilling and CNC lathes tools storage, as well as punches and matrix plate-bending tools.

Inner perforation of telescopic drawers allows mounting shelves for different tools storage and adjusts shelves' height with a 25 mm pitch.

 860×1200×1300 mm

Default colors combination is RAL 5021 (turquoise), RAL 9005 (black) and RAL 9010 (white). Matte paint texture

 700 kg per unit  80 kg per shelf

Demountable construction provides an easy transportation; an assembled cabinet can be moved with a stacking truck or a loader.

The inner perforation of cabinet's shelves can be provided according to customers' requirements.

7a PO-SHK/VT Tool cabinet's inner shelf with a mat

Tools cabinet's inner shelf can be installed inside the drawer console and is equipped with anti-slip mat.

 140×30×1200mm

7b PO-35-SHK/VT Tool cabinet's internal shelf with 35mm holing

Tools cabinet's inner shelf can be installed inside the drawer console. It has perforation of 35 mm in diameter with protective plastic inserts.

 140×30×1200mm

7c PO-60-SHK/VT Tool cabinet's internal shelf with 60mm holing.

Tools cabinet's inner shelf can be installed inside the drawer console. It has perforation of 60 mm in diameter with protective plastic inserts.

 140×30×1200mm

7d PFP-SHK/VT Perforated restraining wall

Restraining perforated wall for tools cabinet can be installed between two inner shelves, allows delimiting the space of two adjacent consoles of the cabinet.

 1166×572 mm



8 TT/BT Transportation cart 

Titan series reinforced transportation cart is designed for heavy tools and accessories storage and movement between manufacturing sectors. The cart is established on rotary wheels, 2 of them with brakes, it is also equipped with the convenient handle.

Default colors combination is RAL 5021 (turquoise), RAL 9005 (black) and RAL 9010 (white). Matte paint texture.



Demountable construction facilitates transportation and gives the opportunity to remove main shelves and use internal space for transportation of gauge loads.

Individual selection of dimensions, position and tilt angle and various types of perforation according to customer's requirements is possible.

Transportation cart consists of several modules:



8d TT-B / VT Internal shelf with anti-slip rubber and upturns

Internal shelf should be installed between two inner perforated panels of transportation cart base vertical wall and Restraining Section. The shelf is equipped with anti-slip rubber and upturns.

 100 kg  190×990×33 mm

8e TT-K / VT Internal shelf with anti-slip rubber



Internal shelf should be installed between two inner perforated panels of transportation cart base vertical wall and Restraining Section. The shelf is equipped with anti-slip rubber.

 100 kg  190×990×20 mm

8a TT-01/VT Transportation cart base

The bottom of the transportation cart base structure is covered with 3mm anti-slip rubber; the vertical wall is equipped with two additional lateral shelves with up to 30 kg load capacity each and a convenient handle.

Sectional construction of the trolley makes it possible to use the entire internal space for dimensional goods transportation.

 700×1200×1500 mm  up to 700 kg

8b TT-OS / VT Restraining Section



Should be installed on the opposite side of the trolley's vertical wall with holder, allows limiting the inner zone of the trolley and installing internal shelves between two inner perforated panels.



 700×810×113 mm

8c TT-P / VT Internal shelf with perforation

Internal shelf should be installed between two inner perforated panels of transportation cart base vertical wall and Restraining Section.



The shelf is equipped with tool storage system designed for reliable fixation of milling, drilling and CNC lathes tools which is represented by two types of perforation (30 mm and 56 mm in diameter) with protective plastic inserts.

 100 kg  190×990×20 mm

9 Shelving STS/VT   

Reinforced shelving with four height adjustable shelves. No additional floor leveling required.

Available in RAL 9005 (black) и RAL 9010 (white) colors. Matte paint texture.

 per unit 800 kg  per shelf 350 kg









10 Movable workstation VTM 



Titan series movable workstation is a compact movable workbench with four drawers and four reinforced polyurethane wheels, two of which are equipped with a stopper; it prevents a workbench rolling during a working process. Movable workstations are equipped with five small and one bigger separate sections for accessories on a working surface; it is also equipped with side shelves below the tabletop and a convenient handle.

Can be additionally equipped with the perforated cover screen and the hinged lamp.

-  workstation 600×900×500 mm  130 kg
-  two drawers 400×160×435 mm
-  two drawers 400×80×435 mm



Default colors combination is RAL 5021 (turquoise), RAL 9005 (black) and RAL 9010 (white).

Matte paint texture.

-  per working surface 150 kg
-  per telescopic drawer 80 kg

10a Perforated cover screen for movable workstation PFP/VTM

Perforated cover screen is designed for tools and additional accessories storage above the tabletop working area. The cover screen should be attached to the backside of the mobile workstation by screw connection and allows locking of working zone of the movable station with a key if necessary.

-  600×505×100 mm  20 kg

10b Hinged LED lamp DL/VT

Metal case with LED lamp is fastened in the central zone of the perforated screen.

-  457×40×10.8 mm

ADDITIONAL ACCESSORIES FOR PERFORATED PANELS OF HEAVY WORKBENCH AND MOVABLE WORKSTATION

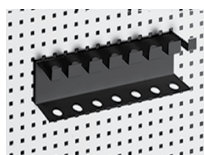

K-01/VT Hook for tweezers and equipment with small handles.
 174×70×40 mm



K-06/VT Hooks for spanners.
 188×181×52 mm



K-07/VT Double hook for heavy instruments.
 37×41×92 mm

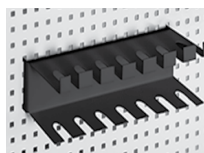

K-02/VT Hook for screwdrivers.
 174×70×40 mm

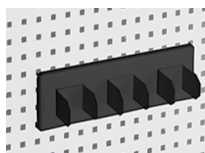

K-04/VT Hook for any tools.
 174×45×35 mm

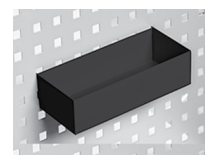

K-08/VT Tray for small components and bottles.
 174×45×82 mm

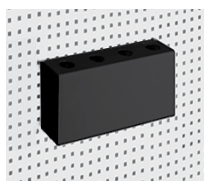

K-03/VT Holder for pliers.
 174×85×47 mm



K-05/VT Holder for screwdrivers and 9-13 mm diameter drills.
 175×100×32 mm

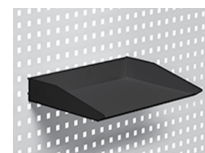

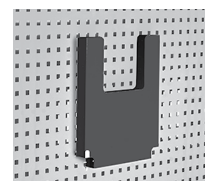

K-09/VT Tray for A4-size papers.
 311×45×225 mm



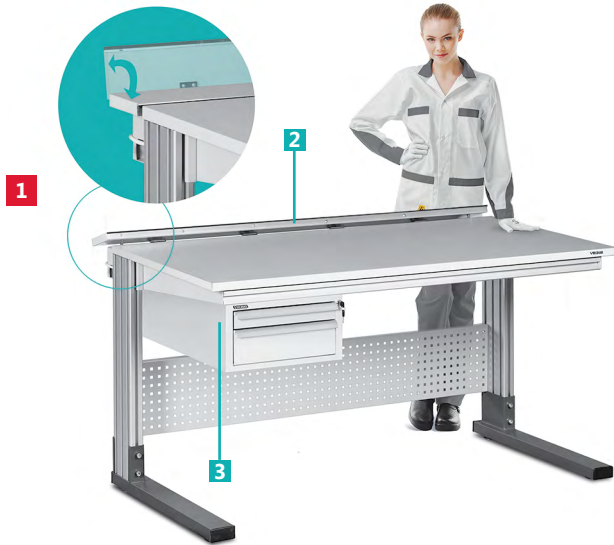

K-10/VT A4-size papers holder.
 233×289×30 mm

SPECIALIZED WORKBENCHES



1 ALF-U Alpha Simplified  

Simplified Alpha series workbench without upper modules. Alpha universal workbenches allow several extensions: optional drawer unit, box with protective plastic fibers and power panel

2 EPA-ALF-U Box with protective plastic fibers on box lid's edges  

Metal box with power panel is mounted to the back side of ALPHA universal workbench. The box's lid is covered with plastic fibers to protect power panel from dust and cuttings. Can be also used as a worktop extension which makes the workbench depth 180 mm more. Power panel consists of 8 sockets in an aluminum case with protective contact and 3 m cable. Nominal load capacity: 10 A.

Available in technical and ESD versions.

3 Optional drawer units  

3a Optional drawer units with reduced depth 

Storage solution for tools and components, no place on floor required. Those with reduced to 490 mm depth allow installing various additional equipment under a tabletop.

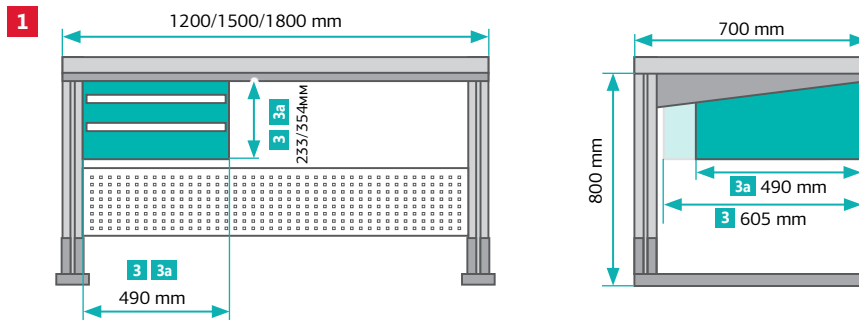

SPECIALIZED WORKBENCHES FOR OPTICAL FIBER HANDLING



Two different types available for purchase: Workbench set and single workbench.

1 SET SOV-12/15/18 ESD Specialized workbench set for optical fiber handling 

The set includes workbench itself, 300 mm main shelf and lighting. Workbench's worktop and main shelf are covered with black ESD plastic (RAL 9005) to provide convenience for optical fibers works. Available only in ESD version.

 650–950 mm  300 kg  300°C

2 SOV-12/15/18 Classic ESD Specialized workbench for optical fiber handling 

Workbench's worktop is covered with black ESD plastic (RAL 9005) to provide convenience for optical fibers works. Available only in ESD version.

 650–950 mm  300 kg  300°C

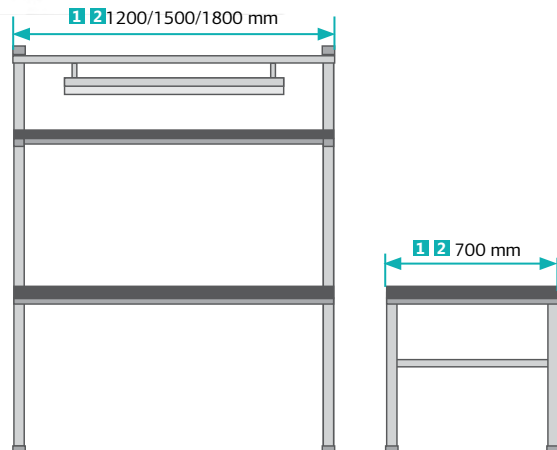

SU Universal workbenches



UNIVERSAL workbenches do not allow any upper extension, but can be placed in a line with no gaps. 700 mm and 900 mm depth SU workbenches can be equipped with all types of Optional drawer units.

650–950 mm 300 kg

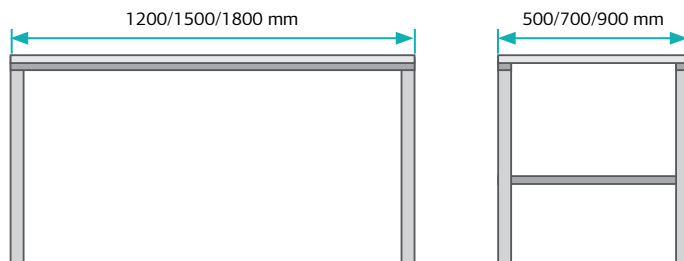

SK-01 Movable computer equipment workbench



Space-saving movable workbench for computer and measurement equipment storage and transportation.

Movable workbench is equipped with four 50 mm casters, two of which are with brakes and PPK-02 keyboard support.

785–1040 mm 300 kg

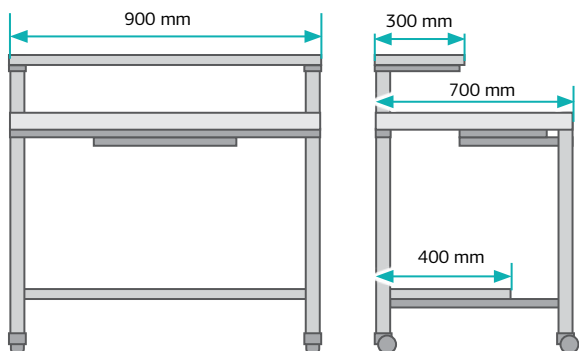

USS-SU-7/9 Corner connecting workbench



Corner connecting workbench is used to build up inseparable working area being a connector for two standard Classic, Comfort or Constant workbenches put at right angle. Increased depth of tabletop and load capacity of 200 kg allows storing and using heavy or bulky equipment.

Corner connecting workbench is produced in 2 sizes to match 700 mm depth workbenches and 900 mm depth workbenches. Perforated panel, main and additional shelves, lighting units and power panels can be mounted to corner connecting workbench on request.

670–930 mm 300 kg

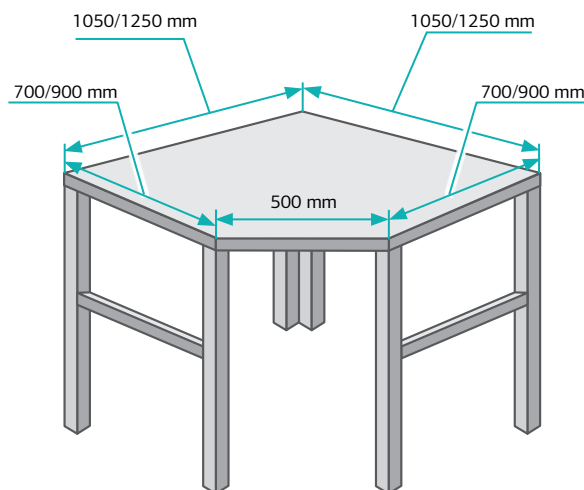

WIRE HARNESS WORKBENCH



Wire harness workbench with 0° to 80° angle adjustable worktop made of 1.5 mm thick powder-painted steel allows using magnetic plates with holders, retainers, corner posts and wire breakout systems which help to hold wires and form bundles on wire harness workbench. Magnetic plates are equipped with two potent (with 20 kg/s pull off force) magnets each thus allowing the usage of up to 5 kg bundles without their spontaneous movements.

Worktop angle adjustment and fixation is performed by side clamping handles.

Workbench supports unit dimensions: 1425×690 mm.



Steel worktop available in three versions (width×height)

- SR-ZHG-15 (1500×1400 mm),
- SR-ZHG-18 (1800×1400 mm),
- SR-ZHG-20 (2000×1400 mm).



Workbench height

- in horizontal position of the worktop — 800 mm
 - in vertical position of the worktop — 1760 mm
- Available only in technical version.
Supplied in a set with casters.

 70 kg



WIRE HARNESS WORKBENCH ACCESSORIES

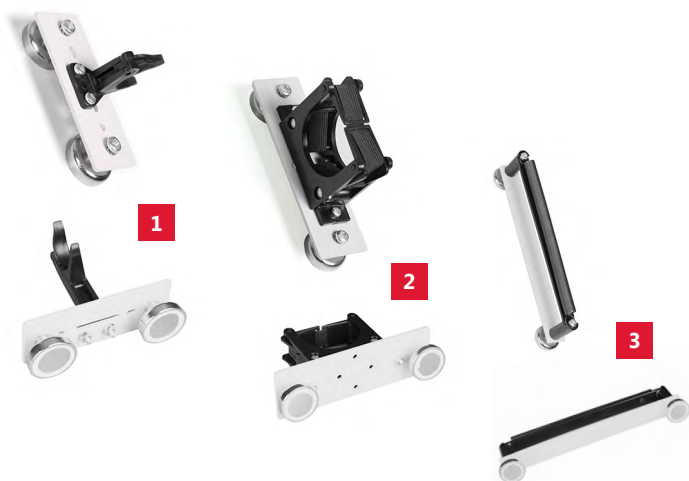

TYPE OF THE MAGNETIC PLATE	USED FOR HOLDERS	DIMENSIONS OF THE PLATE, MM
1 MP-ZHG-1	RER75-S6-X ER.5-E4-X CPH.75-S8-X CPL.75-S8-X	30×80
2 MP-ZHG-2	RER2.0-S6-X ER1.25-E4-X	35×110
3 MP-ZHG-3	SHH3-S8-X	20×190

Different types of holders, retainers, corner posts and wire breakout systems, which help to hold wires and form bundles on wire harness workbench. They should be mounted on one of three types of magnetic plates.

CODE	DIMENSIONS (W×H×D)	MAX. BUNDLE DIAMETER	COMMENTS
1 Harness elastic retainer			
RER.75-S6-X	30×56.1× ×28.4 mm	19 mm	Cable bundles are formed as cable bundles are inserted. Completed bundles can be easily removed
Harness replacement elastic band for RER.75-S6-X.			
RER.75E-X			The elastic band is replaceable
2 Harness elastic retainer			
RER2.0-S6-X	33.3×100.2× ×71.4 mm	50.8 mm	Cable bundles are formed as cable bundles are inserted. Completed bundles can be easily removed
Harness replacement elastic band for RER2.0-S6-XX			
RER2.0E-X			The elastic band is replaceable
3 Low profile elastic retainer			
ER.5-E4-X	49.8×25.4× ×14.2 mm	12.7 mm	Cable bundles are formed as cable bundles are inserted. Completed bundles can be easily removed
ER1.25-E4-X	73.7×50.8× ×24.1 mm	31.8 mm	
4 Corner post			
High profile corner post			
CPH.75-S8-X	22.9×47.8× ×40.8 mm	19 mm	Designed to pre-form tight bundles at harness corners and breakouts. Top arm rotates upward for easy removal of completed harness
Low profile corner post			
CPL.75-S8-X	22.4×27.4× ×38.6 mm	19 mm	

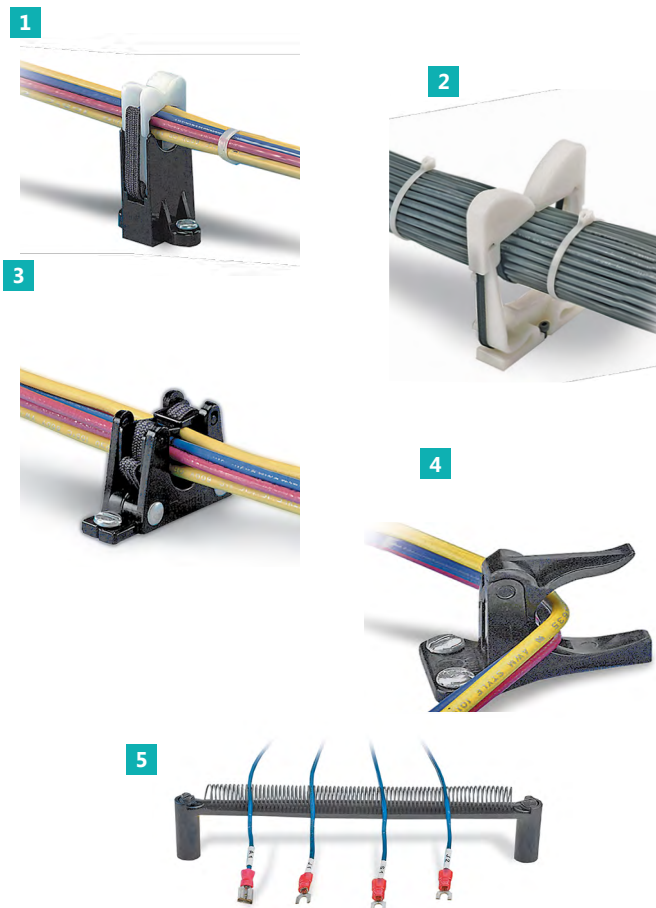

5 Spring wire breakout system

Harness board spring and spring linkage holds wire ends secure while harness is being fabricated. Wires simply pull out from spring when harness is removed.

CODE	DESCRIPTION	SPAN BETWEEN FASTENINGS (LENGTH)	COMMENTS
SHH3-S8-X	Linkage for wire breakout system	172.7 mm	Should be ordered together
PBSC6-X	Spring wire breakout system, should be mounted to linkage	152.4 mm	

CUSTOMIZED LAYOUTS

<https://viking-esd.com/forms/>

We are pleased to offer customized layouts based on our clients' individual requirements and projects. One can change size, shapes, add necessary elements to any particular module. **Minimum order quantity for customized layouts — 5 pieces.**

ST-B movable counter with ESD boxes



SR-VD workbench with movable middle unit



EM-SR-14 Workbench for electrical installation operations



We are pleased to offer customized layouts based on our clients' individual requirements and projects. One can change size, shapes, add necessary elements to any particular module

Minimum order quantity for customized layouts — 5 pieces.

ALF-N ALPHA series workbench with 3 aluminum supports and customized shape worktop



TTL-P Laboratory equipment transportation cart



TTU-N Heavy-duty transportation cart



WORKPLACES ADDITIONAL EQUIPMENT

PO-IP-12/15/18 Tabletop secondary structure



Tabletop secondary structure is an additional module for 900 mm depth Classic workbenches. It is equipped with additional power panel and a 400×360×40 mm drawer. Power panel can also be equipped with additional sockets.

1200/1500/1800×100×430 mm

120 kg

PPK-02 Metal keyboard support



Telescoping metal support saves space on the tabletop. Keyboard support is produced of powder coated steel and available in dark grey (RAL 7012) or light grey (RAL 7035) colors. Keyboard support can be mounted to any workbench series which has enough space under the tabletop (minimum of 615 mm width and 383 mm depth is required).

616×135×383 mm

plate for keyboard 245×505 mm 30 kg

KL-1200 Retracing mechanism



Should be mounted to IP Cantilever module. Designed to suspend instruments and make them easy-to-reach. Cable tension depends on the weight of the instrument.

0.6–1.5 kg

EP Power Panel accessories



Standard power panels can be additionally equipped with a number of additional units:

- Single sockets with grounding
- Double sockets with grounding
- Dust-proof sockets
- 10 A automatic switcher
- 16 A automatic switcher
- Circuit breaker
- Automatic circuit breaker with filter for high-resistance interference sources

PPN-02 Footrest

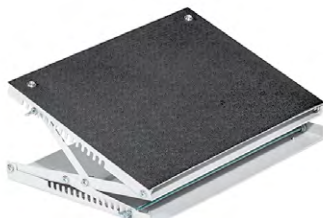

Footrest helps to provide workers with an ergonomically correct sitting position. PPN-02 footrest is equipped with height and angle adjustment mechanism.

400×300 mm

PPCH-01 / PPCH-01/GM Drafts holders



Adjustable drafts holder. Supplied in a set with two VIKING magnets. Requires PO Main shelf or Rear racks for SR series workbenches. Mounted to lateral supports for Gamma series. Rotary segments' length: 150 mm.



of metal plate 430×310 mm



15 kg

PPM-03 / PPM-03/GM Monitor supports



Adjustable monitor holder. Requires PO Main shelf or Rear racks for SR series workbenches. Mounted to lateral supports for Gamma series. Rotary segments' length: 150 mm.



of metal plate 430×310 mm



15 kg

PPS-01 Movable computer case support



Computer support helps moving the computer case around the area.



220×150×480 mm

PPS-03 Suspended computer case support

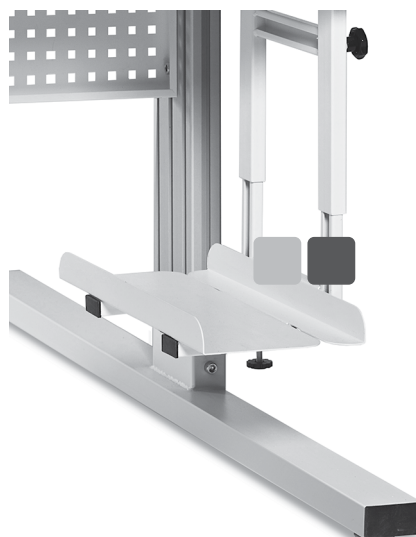

Suitable for any VIKING workbench.



265×460×460 mm

PPN-03/A Suspended footrest for ALLIANCE series workbenches

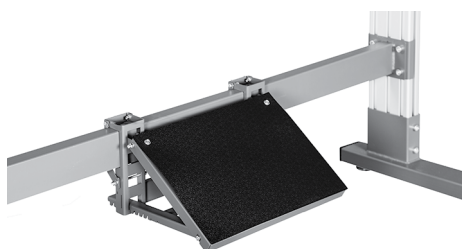

It is only suitable for ALLIANCE series workbenches. The footrest should be mounted to the lower slat and is equipped by a nonskid floor mat. 130° to 160° angle adjustment provides additional convenience for an operator.



of a platform 400×300 mm



60 kg

ARK Bin rail



Aluminum rail can be installed wherever on the wall to hold attached storage bins. Maximum length 3 m.

- Width 95 mm.

DL/N Under-shelf local lighting

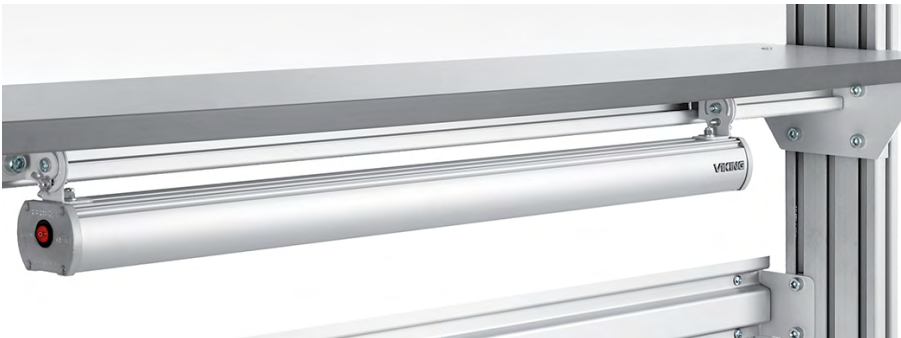

Additional lighting can be mounted under the main shelf or attached to perforated panel. Suitable for any workbench equipped with upper modules. Angle adjustment $\pm 60^\circ$ or 80° depending on the type of workbench.

- 2 versions: 60 cm length and 90 cm length
 - Luminous flux: 3150/4725 Lm
 - Color temperature 4700–5300 K
- Provides at least 1000-lux illuminance at 1000 mm distance from the light source..

PPT-01 Movable drawer unit support



Movable drawer unit support is an additional unit that helps to turn stationary drawer units and cabinets into movable one. It matches all standard cabinets (TMB-01/1 and TMB-02/1) and drawer units (DR-03/1, DR-05/1, DR-07/1 and DR-10/1). Four 50 mm casters, two of which are with brakes.

510x120x600 mm

350 kg

PO-ZHL/VR-PO-ZHL Sliding shutters shelf



Additional shelf with sliding shutters can be mounted to any Classic or Constant (PO-ZHL) and Verstak (VR-PO-ZHL) series standard workbench which has Rear Racks. This additional shelf has two sliding shutters and a lock, which allows safe tools, equipment and documents storage.

1200/1500/1800 x 400 x 300 mm

50 kg

Only available in technical version. Not compatible with SRST middle upright.

PO/K Reinforcing Bracket

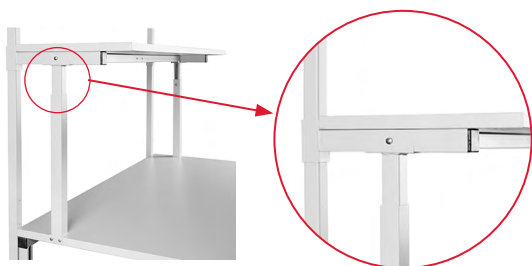



A set of reinforcing brackets for main shelves of CLASSIC, COMFORT, CONSTANT and OSTROV series. Helps to increase Main shelves load capacity up to 100 kg.

KRP/A, KRP/GM Swivel Bracket with interchangeable supports





Universal swivel bracket helps to arrange additional equipment around the working area and maintain operator's ergonomics. KRP swivel bracket can be equipped with three different supports as an attachment: equipment shelf, bin rail or perforated panel.

The system consists of:

- 1** KRP Swivel Bracket unit (KRP/GM for Gamma series).
And one of 3 interchangeable attachments:
- 2** PO-KRP equipment shelf with upturns
 276 × 362 mm
- 3** PFP-PKR perforated panel
 319 × 428 mm
- 4** RK-KRP bin rail
 270 × 466 mm

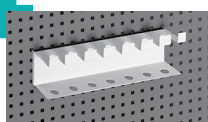
PFP Perforated Panel accessories



K-01 Hook for tweezers and equipment with small handles.
 174×70×40 mm

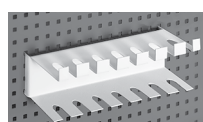

K-02 Hook for screwdrivers.
 174×70×40 mm

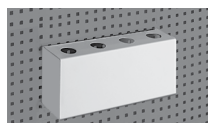

K-03 Holder for pliers.
 174×85×47 mm

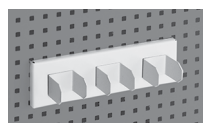

K-04 Hook for any tools.
 174×45×35 mm

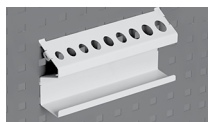

K-05 Holder for screwdrivers and 9–13 mm diameter drills.
 175×100×32 mm



K-06 Hooks for spanners.
 188×181×52 mm



K-07 Double hook for heavy instruments.
 37×41×92 mm

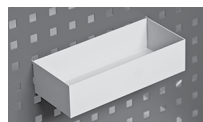

K-08 Tray for small components and bottles.
 174×45×82 mm



K-09 Tray for A4-size papers.
 311×45×225 mm



K-10 A4-size papers holder.
 233×289×30 mm

DRAWER UNITS

SUSPENDED AND MOVABLE DRAWER UNITS



Steel frame drawer units are designed for tools and components storage. Movable and stationary drawer units can be also used as additional workplaces. Steel frame drawer units are equipped with central lock and either 550 mm telescoping drawers or shelves. Movable units have four rubber casters, two of which are with brakes. We also offer suspended drawer units with reduced to 490 mm depth, which allow installing various additional equipment under a tabletop.

Drawers' inner dimensions for different types are:

- A** — standard 400×45×505 mm **B** — standard 400×100×505 mm
- C** — standard 400×160×505 mm **D** — standard 400×200×505 mm
- a** — reduced 400×45×426 mm **b** — reduced 400×100×426 mm

 per drawer 30 kg

Reduced drawers

DRAWER UNITS ↘	SUSPENDED				MOVABLE	
	TP-01/P	TP-02/P	TP-10/P	TP-20/P	TP-01/S	TP-02/S
Picture number	1	2	3	4	5	6
Dimensions (W×H×D), mm	490×354×605	490×233×605	490×354×490	490×233×490	490×610×580	490×650×635
Quantity of drawers	3	2	3	2	3	4
Drawers per unit	A	1	1	–	–	1
	B	2	1	–	–	2
	C	–	–	–	–	1
	a	–	–	1	1	–
	b	–	–	2	1	–
Weight (kg)	20	15	17	12	25	32

When ordering, please mention whether ESD or technical version, and whether dark grey RAL 7012 or light grey RAL 7035 color required.

STATIONARY CABINETS AND DRAWER UNITS

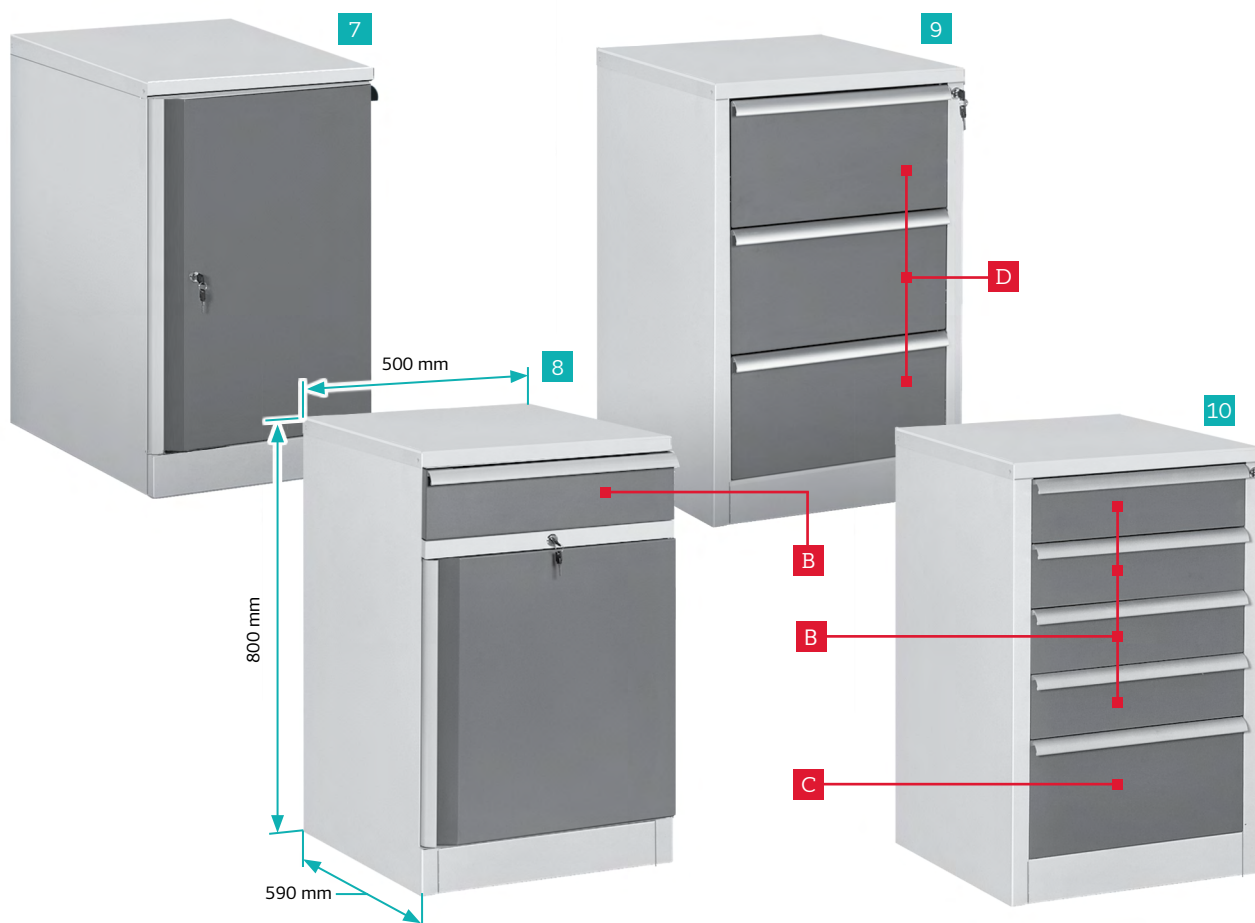

Steel frame stationary cabinets and drawer units are designed for tools and components storage and can be also used as additional workplaces. All stationary cabinets and drawer units can be installed as worktop supports for CONSTANT series workbenches and VERSTAK series technical workbenches. All standard stationary cabinets and drawer units are bicolored by default.

Stationary cabinets and drawer units have /1 in code if standing separately (for example, DR-07/1) and are indicated without additional number in code if used as VERSTAK or CONSTANT series support (for example VR-12+DR-03).

	STATIONARY			
	TMB-01/1	TMB-02/1	DR-03/1	DR-05/1
Picture number	7	8	9	10
Dimensions (W×H×D):	500×800×590 mm	500×800×590 mm	500×800×590 mm	500×800×590 mm
Quantity of drawers /shelves	2 shelves	1 drawer, 1 shelf	3 drawers	5 drawers
Drawers per unit				
B	-	1	-	4
C	-	-	-	1
D	-	-	3	-
Weight (kg)	25	30	35	40

When ordering, please mention whether ESD or technical version required.

ENLARGED CABINETS AND DRAWER UNITS

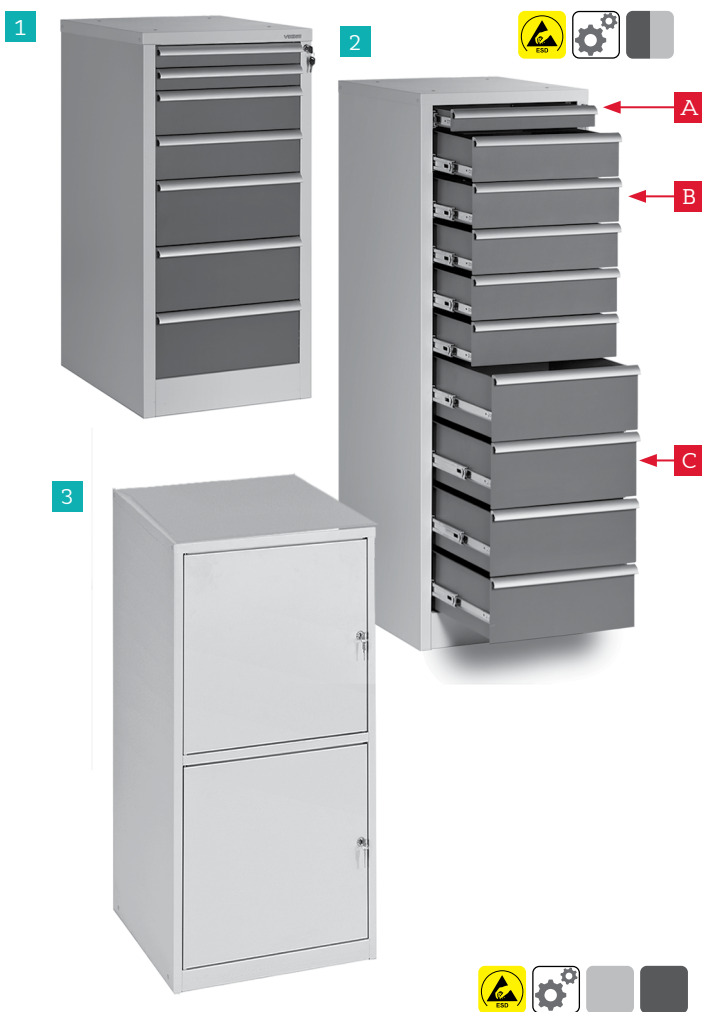

DRAWERS DIVIDERS



Steel frame enlarged stationary drawer units are designed for tools and components storage; can be also used as additional workplaces. DR-07/1 and DR-10/1 enlarged stationary drawer units are bicolored by default. For TMB-03/1 cabinet, please, mention whether dark grey RAL 7012 or light grey RAL 7035 color required. All cabinets and drawer units have /1 in code if standing separately (for example, DR-07/1).

Drawer's inner dimensions:

A — standard 400×45×505 mm **B** — standard 400×100×505 mm

C — standard 400×160×505 mm

	DR-07/1	DR-10/1	TMB-03/1
Picture number	1	2	3
Dimensions (W×H×D):	500×1040×590 mm	500×1520×590 mm	540×1050×500 mm
Quantity of drawers	7	10	2 closable sections
Drawers types per unit	A	2	1
	B	2	5
	C	3	4
Weight (kg)	55	75	20

ALPHA CABINET

Drawer dividers sets

Dividers help to organize drawer internal space according to specific needs.

One can modify the space to many cells according to the number and dimensions of items needed to store: instruments, PCBs, mounting elements or other items.

1 D-10/A / DM-10/A sets

D-10/A

Dividers for type A standard drawers (400×45×505 mm).

DM-10/A

Dividers for type A reduced drawers (400×45×426 mm).

Each set consists of 4 longitudinal and 6 transversal dividers. Up to 35 different sized cells can be organized.

2 D-11/B / DM-11/B sets

D-11/B

Dividers for type B standard drawers (400×100×505 mm).

DM-11/B

Dividers for type B reduced drawers (400×100×426 mm).

Each set consists of 3 longitudinal and 4 big and 4 small profiled transversal dividers. Up to 10 different sized cells can be organized.

3 D-16/B

Dividers for type B standard drawers (400×100×505 mm). The set consists of 4 longitudinal and 6 medium and 6 small profiled transversal dividers. Up to 15 different sized cells can be organized.

4 KD/AB mat

ESD mat that should be ordered separately if drawers dividers set is being ordered for technical version cabinets. KD/AB mat is necessary to provide drawers dividers set stability and reliability.

5 Additional equipment for drawers – plastic ESD trays

ESD inserts for components and personal belongings convenience storage are made to match standard type A and type B drawers. ESD inserts are produced of 2.2 mm thick black dissipative polystyrene. Max temperature 60°C.

Available in two versions:

- V-01 ESD, Antistatic inserts for type A standard drawers (400×45×505 mm). Insert contains 9 cells of different shape and dimensions: one 375×112 mm cell, four 182×112 mm cells, and four 86×112 mm cells.
- V-02 ESD, Antistatic inserts for type B standard drawers (400×100×505 mm). Insert contains 8 similar dimensions cells 112×182 mm each.

ALF-TMB-02 cabinet



Spacious metal cabinet for documents, folders and personal belongings; can be attached to workbench by bolts. Cabinet has 2 standard drawers and 2 sliding shelves, each has a perforated side wall, which can be placed on right or left side depending on further usage. ALF-TMB-02 cabinet only available in technical version. Cabinet can be attached to any ALPHA series workbench from either side.

445×1285×700 mm
per shelf 30 kg

SHELVES DIVIDERS FOR ALF-TMB-02 CABINET

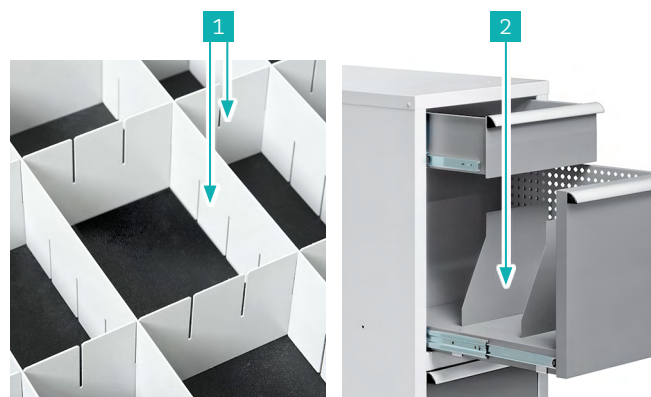

1 D-7/ALF-2 Horizontal dividers



Seven horizontal 335 mm length dividers help to organize cells for different small items.

2 D-4/ALF-2 Vertical dividers



Four vertical 240×290 mm dividers help to organize slots for folders and documents.



MOVABLE TABLES AND CARTS



1 AI-PS Alliance Movable table   



Movable table is used for tools and components storage and transportation. Equipped with four 75 mm casters, two of which are with brakes and three shelves, middle one with height's adjustment.

 690×840×460 mm  150 kg

6 PS-10 movable table with suspended drawer unit   

Movable table with TP-02/P suspended drawer unit can be used as additional workplace. Movable table is equipped with four 75 mm casters, two of which are with brakes.



 650–950 mm

2 3 4 PS-07, PS-10, PS-15 movable tables **5** PS-07 Comfort   



Movable tables are used for tools and components storage and transportation. All movable tables are equipped with four 75 mm casters, two of which are with brakes.

 650–950 mm

CODE	PS-07	PS-10	PS-15	PS-07 COMFORT
Picture number	2	3	4	5
Load capacity per surface		150 kg		100 kg
Dimensions, W×D	710×515 mm	700×1000 mm	700×1500 mm	710×515 mm

7 GM-PS Gamma movable table   

Movable table is used for tools and components storage and transportation. Equipped with four 75 mm casters, two of which are with brakes and three shelves.

 570×910×700 mm  overall up to 200 kg  lower shelf up to 100 kg

For ESD version with turquoise (RAL 5021) edges, for technical version - with light gray edges. Shelves are not height adjustable. Can be additionally equipped with EPA-PS-GM power panel on the back side.



8 9 10 TT-02, TT-03, TT-04 transportation carts



Transportation carts are used for tools and components storage and transportation. Metal carts are equipped with four 75 mm (for TT-02, TT-03 carts) or 125 mm (for TT-04 cart) casters, two of which are with brakes, and height adjustable shelves.

CODE	TT-02	TT-03	TT-04
Picture number	8	9	10
Dimensions (W×H×D):	470×990×840 mm	615×1560×1270 mm	615×1560×1270 mm
Quantity of shelves	2	3	4
Shelves height adjustment	140–800 mm	140–800 mm	190–1480 mm
Load capacity (kg)	100 kg	100 kg	100 kg

When ordering, please mention whether ESD or technical version, and whether dark grey RAL 7012 or light grey RAL 7035 color required.

MOVABLE TROLLEYS



1 AL-ST Equipment trolley



Equipment trolley is designed for additional equipment storage and transportation. It has five height adjustable shelves and a half-size power panel with four sockets and a switch. The panel is located on the side frame thus does not occupy any space on shelves. Equipment trolley side frames are manufactured of aluminum profile, which allows attaching small elements, and gives the whole unit elegant look. Trolley has four casters, two of which are with brakes as supports.

 690×1940×460 mm

 150 kg

2 ST-05 Movable trolley

3 ST-05 Comfort Movable trolley



Movable trolleys are used for tools and components storage and transportation.

Each trolley is equipped with five height-adjustable shelves and a power panel with five grounded and one ungrounded socket, and four casters, two of which are with brakes. Lateral position of power panel.

CODE	ST-05	ST-05 COMFORT
Dimensions, W×H×D	600×1600×500 mm	680×1600×460 mm

 lower shelf 600×460 mm

 four upper shelves 600×400 mm

 150 kg

4 ST-06 Movable trolley



Movable trolley is used for tools and components storage and transportation.

Trolley is equipped with five height-adjustable shelves and four casters, two of which are with brakes. No power panel included.

 600×1605×500 mm

 150 kg

5 GM-ST Gamma movable trolley





Movable trolley is used for tools and components storage and transportation. Equipped with 5 shelves and a built-in power panel with 5 sockets and a switch.

Four 75 mm casters, two of which are with brakes.



 lower shelf 592×592 mm

 200 kg

 upper shelves 600×500 mm

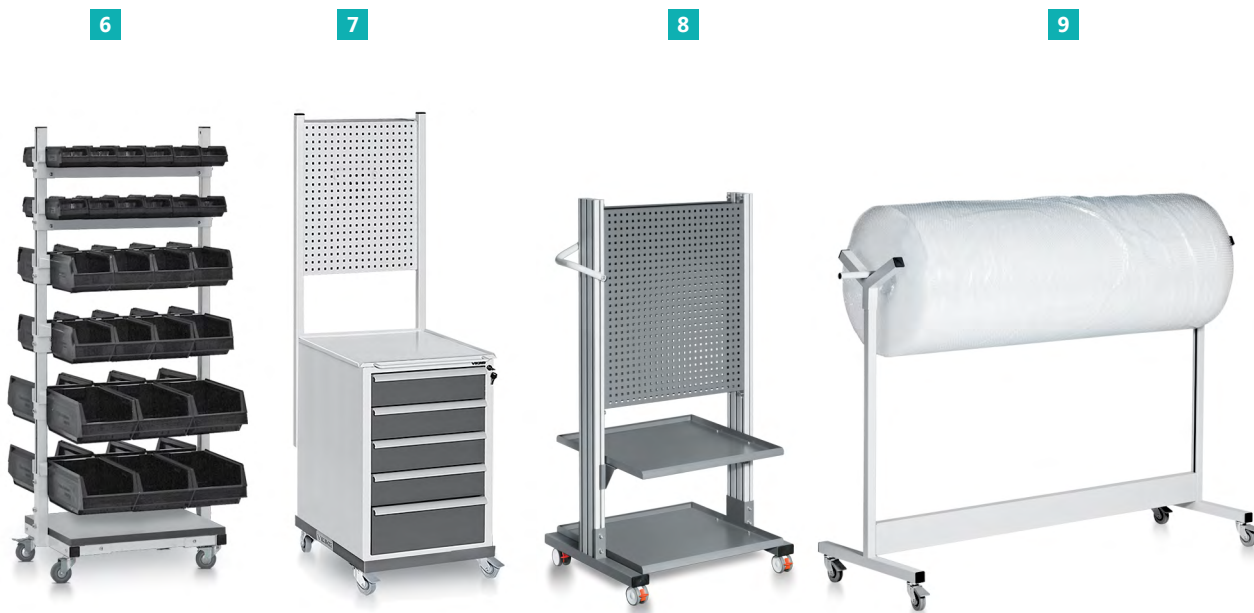
 Each shelf 200 kg







6 SKM Dual movable trolley   

Dual Movable trolley for accessories is made of a rack coated with conductive powder paint, thus available only in ESD version. Lower shelf made of ESD laminated chipboard 25 mm thick. Trolley is equipped with four 75 mm casters (2 of them with brakes) and six rails for boxes. Attachable bins should be ordered separately.

Each of 2 sides of bin rails can be additionally equipped with:

- 6 pcs of COCIS-A
- 6 pcs of COCIS-B
- 4 pcs of COCIS-C
- 3 pcs of COCIS-E





 680x1600x460 mm  100 kg



8 ST-VR-01 Movable equipment trolley   

Convenient equipment trolley with side handle allows tools and equipment storage on upper perforated panel and two lower shelves.

All standard hooks (K-01-K10) can be mounted to upper perforated panel.

Movable trolley equipped with four casters, all with brakes.

 800x1600x690 mm  shelves 695x665 mm
 per trolley 250 kg  per shelf 100 kg



7 ST-R Movable repairing trolley   

The trolley is equipped with two-sided 525x600 mm perforated panel above the trolley's tabletop and a drawer unit with five telescoping drawers lower.

 of the trolley 600x630x1730 mm



 of the drawer 800x500x590 mm

 for perforated panel 10 kg

9 SUS Movable packing trolley   

Auxiliary trolley, designed for convenient polyethylene, damping film, paper and other packaging materials rolls clamping; maximum roll's width — 1.5 m.

Movable packing trolley equipped with four 50 mm casters, all with brakes.

 1240x600x1800 mm  80 kg

CABINETS AND WARDROBES



1a 2 3 4



1a



2



3



1b



1b

All cabinets have central lock.

Filing and combined cabinets have three or four height adjustable shelves with 50 mm pitches.

For wardrobe and combined cabinets garment bar included.

For SHDZH Sliding shutters cabinets inner dividers included.

For SHKH cabinets 16 (SHKH-2) to 30 (SHKH-1) 360 mm telescoping drawers with outer dimensions of 310×100×370 mm included.



per surface — 30 kg

PICTURE NUMBER		DIMENSIONS (W×H×D), MM	WEIGHT, KG
SHD-1, SHD-2 Filing cabinets			
1a	SHD-1	1000×1950×550	80
	SHD-2	820×1850×450	62
1b	SHD-3	820×1000×450	40
SHO-1, SHO-2 Wardrobe cabinets			
2	SHO-1	1000×1950×550	68
	SHO-2	820×1850×450	52
SHK-1, SHK-2 Combined cabinets			
3	SHK-1	1000×1950×550	78
	SHK-2	820×1850×450	58
SHKH-1, SHKH-2 Drawers cabinets			
4	SHKH-1	820×1850×450	127
	SHKH-2	820×1060×450	69

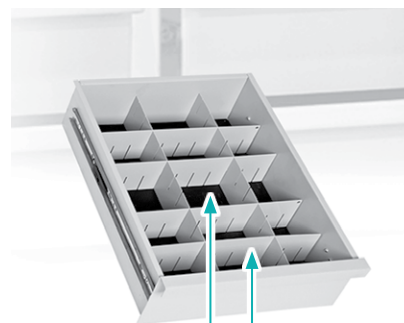

7 6



5 SHDI-1 Tools storage cabinet



Tools storage cabinet is equipped with five 460/2×130×550 mm retractable drawers with middle divider each.

530×1400×605 mm 100 kg 55 kg

6 D-6/SH

Dividers for type SHKH drawers (360×100×310 mm). The set consists of two longitudinal and four transversal dividers. Up to 15 different sized cells can be organized.

7 KD/SH mat

ESD mat that should be ordered separately if drawers dividers set is being ordered for technical version cabinets. KD/SH mat is necessary to provide drawers dividers set stability and reliability.

8 SHDZH-1 Sliding shutters cabinet



SHDZH-1 Sliding shutters cabinet is a compact metal cabinet with two sliding shutters and a lock in the middle. Each section equipped with two shelves and inner dividers to provide convenient documents storage.

615×1660×405 mm per shelf 25 kg

Available only in technical version

9 SHO-3 Two-section garment wardrobe



Two-section garments wardrobe is equipped with four shelves (two for each section), 2 rods with hooks for garments and additional perforation that provides ventilation of the inner zone.

600×1750×500 mm 59 kg

DRY STORAGE CABINETS

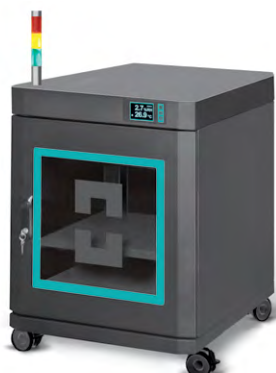

1



2



3

DC ESD series dry storage cabinet is a line of special equipment designed to provide ultra-low ranges of relative humidity, which is necessary for handling moisture-sensitive components and materials including precision metal parts, printed circuit boards, plates, nano fibers, cassettes, laboratory samples, electronic modules.

All DC ESD series cabinets produced only in antistatic (ESD) version, in strict compliance with ESD safety regulations of IEC 61340-5-1. For dry storage cabinets we use only specific ESD glass with conductive surface (conductivity $10^3 - 10^5$ Ohm) and ESD wheels. All the shelves and horizontal surfaces of the cabinet are grounded and ESD coating of all metal elements is applied. All cabinets are supplied in a set with one middle shelf for each section.

DC ESD series dry storage cabinets feature low noise level and equipped with temperature and humidity levels indication and door alarm system.

CODE	DC-1 ESD	DC-2 ESD	DC-3 ESD	DC-4 ESD	DC-6 ESD
Picture number	1	2	3	4	5
Number of doors	1	2	3	4	6
Dimensions, W×H×D, mm	600×737×640	600×1342×640	600×1947×640	1205×1342×640	1205×1947×640
Capacity, liters	238	454	670	900	1340
Weight, kg	60	100	131	170	227

All DC series cabinets are equipped with **RS-232 port** that allows data collection. One should simply connect DC dry cabinet to a computer using standard cable.

DC series cabinets feature humidity & temperature display with parameter value input on easy-to-operate three buttons digital control LCD-panel. Humidity and temperature monitoring is performed by the built-in precision sensor with digital interface, processor and LCD display. Monitoring is performed by a sensor, based on CMOS technology, each sensor is being factory calibrated prior to installation.

DC ESD series dry cabinets are available in:

- White** **RAL 9010** (code DC-W ESD, for example DC-3W ESD for 3-doors white cabinet)
- Light grey** **RAL 7035** (code DC-G ESD, for example DC-6G ESD for 6-doors grey cabinet)
- Black** **RAL 9005** (code DC-B ESD, for example DC-1B ESD for 1-door black cabinet)



4

5

TECHNICAL SPECIFICATIONS	VALUE
Humidity range	1-50%
Precision	±1%
Absorption of moisture	automatically regenerated absorbent (Zeolite)
Max. dimensions of units to store	500×510×570 mm
Door alarm	integrated
Power consumption	200 ±22 W
Max. power consumption	Up to 350 W in regeneration phase, 5W in storage phase
IP protection class	IP 55

DC ESD dry cabinets meet or exceed international standards:

IPC / JEDEC J-STD 033C

«Handling, Packing, Shipping and Use of Moisture/Reflow Sensitive Surface Mount Devices»;

IPC / JEDEC J-STD-020C

«Moisture/Reflow Sensitivity Classification for Nonhermetic Solid State Surface Mount Devices»;

EIA / IPC / JEDEC J-STD-075

«Classification of Non-IC Electronic Components for Assembly Processes».

DESICCATION AND RECOVERY TIME

Recovery Time – is one of the most critical performance parameters of any dry storage cabinet, it refers to the time required for the cabinet to reduce the RH level back to its set point after the door been opened and closed.

Desiccation or recovery time	3-doors cabinet with 1 dehumidifier unit	1-door cabinet with 1 dehumidifier unit or 6-doors cabinet with 2 dehumidifier units
Desiccation 50% to 1% RH	≤ 1 hour 40 mins	≤ 1 hour 20 mins
Desiccation 50% to 5% RH	≤ 60 mins	≤ to 40 mins
Recovery time <10% RH*	≤ 4 mins	≤ 1 min
Recovery time <5% RH*	≤ 8 mins	≤ 3 mins
Recovery time <3% RH*	≤ 15 mins	≤ 7mins
Recovery time <1% RH*	≤ 5 mins	≤ 13 mins
Recovery time <1% RH**	≤ 35 mins	≤ 18 mins

* After 10 sec door opening.

**After 20 sec door opening.

Recovery tested at 50%RH @ 25°C

ADDITIONAL EQUIPMENT

- | | |
|---|----------------------------------|
| 1 Swivel supports (to replace casters) | S-DC |
| 2 Light Tower | C-DC |
| 3 Additional adjustable shelves | SHW-DC, SHG-DC, SHB-DC |
| 4 LED internal lighting | L-DC |
| 5 Additional automatic nitrogen unit | A-DC |
| 6 Shelves separation elements | LIW-DC, LIB-DC, LIG-DC |
| 7 SMD Reels adjustable rack | SCO-W-DC, SCO-G-DC, SCO-B-DC SMD |

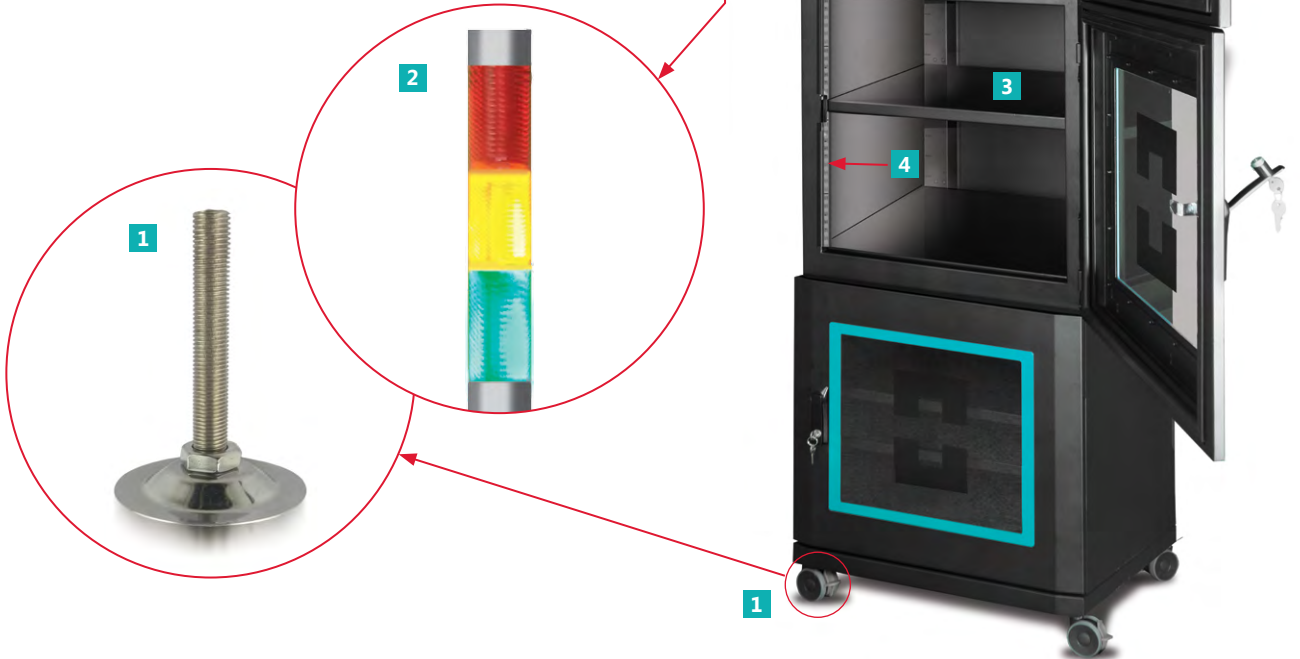

6 LIW-DC/LIB-DC/LIG-DC
Shelves separators

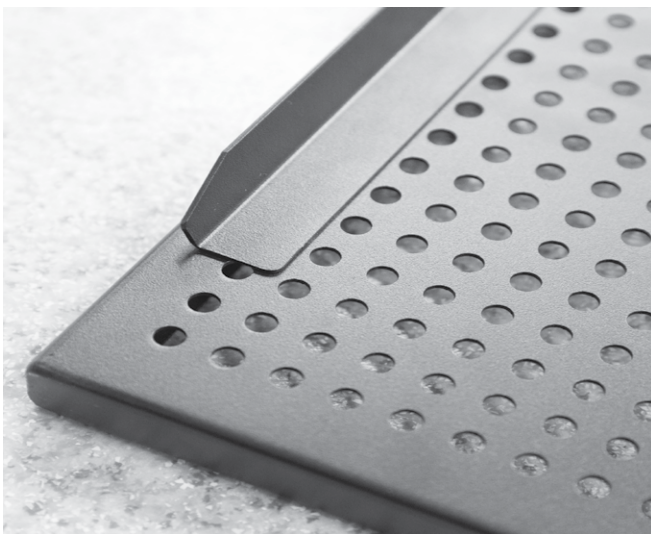

Mounted on a standard dry storage cabinet shelf. Limits the inner space of the shelf for components storage. Can be installed in both positions – along and across the shelf.

Available in:

- White** RAL 9010 (code LIW-DC)
- Light grey** RAL 7035 (code LIG-DC) or
- Black** RAL 9005 (code LIB-DC)

7 SCO-W-DC/SCO-G-DC/SCO-B-DC
SMD Reels adjustable rack

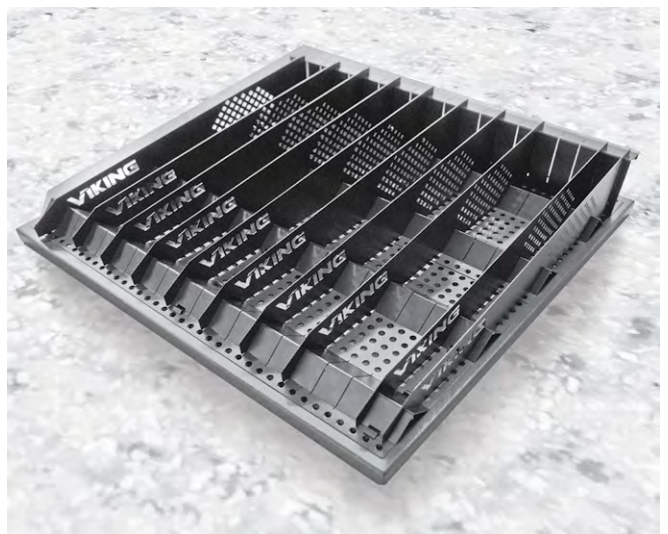

SMD Reels adjustable Rack is mounted on a standard dry storage cabinet shelf. Allows organizing three rows for 82-215 mm diameter SMD reels. Minimum width of each cell is 27 mm.

Available in:

- White** RAL 9010 (code SCO-W-DC)
- Light grey** RAL 7035 (code SCO-G-DC) or
- Black** RAL 9005 (code SCO-B-DC)

SHELVING



1



2



3

1.2 STU Shelving



Shelving is used for documents and components storage. Shelvings (except for the STU-01) have height-adjustable supports and five height adjustable shelves with 50 mm pitches.

For STU-01 there are six height adjustable shelves with 50 mm pitches.

per shelf — 30 kg per unit — 180 kg for STU-01

per unit — 110 kg for STU-02, STU-03, STU-04, STU-05

Nº	CODE	Dimensions, mm
1	STU-01	820×1850×450
	STU-02	820×1850×390
2	STU-03	1000×1850×490
	STU-04	820×1950×390
	STU-05	1000×1950×490

When ordering, please mention whether ESD or technical version, and whether dark grey RAL 7012 or light grey RAL 7035 color required.

3 STS Reinforced shelving



Height-adjustable supports. Four height adjustable shelves with 50 mm pitches. No additional floor leveling required.

per shelf - 350 kg per unit - 800 kg

Nº	CODE	Dimensions, mm
3	STS-12	1200×1800×600
	STS-15	1500×1800×600

PL-1, PL-2, PL-ST5-12, PL-ST5-15
Additional shelves



Additional shelves for cabinets and shelving

SHELF	TO BE USED FOR
PL-1	SHD-1, STU-03, STU-05
PL-2	SHD-2, SHD-3, STU-01, STU-02, STU-04
PO-ST5-12	STS-12
PO-ST5-15	STS-15

MODULAR COUNTERS

MODULAR TURNTABLE COUNTER

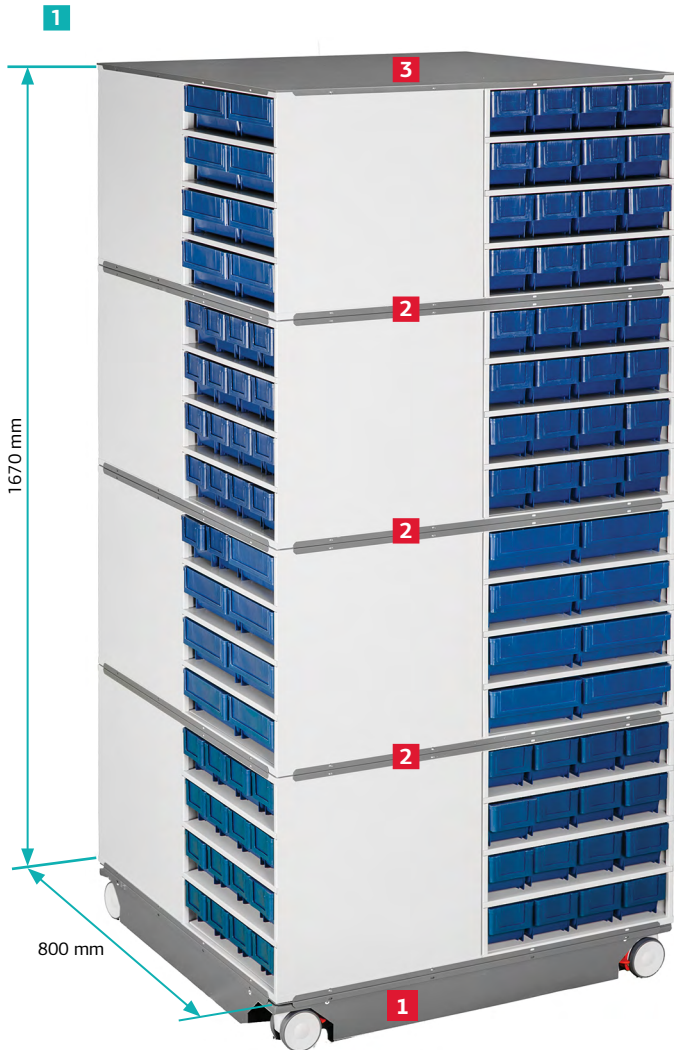

2



3



4



Turntable modular storage counter is a practical and high-capacity solution for components and tools keeping, that provides convenience of its usage in different production processes.

Turntable modular counter is equipped with bin cabinets containing two types of plastic bins: narrow and wide.

- **narrow** bins with up to of 2.4 liter volume

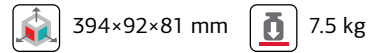

- **wide** bins with up to 4.3 liters volume

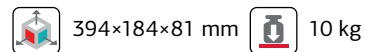

Turntable modular storage counter can be ordered as a complete set or partially.

Modular storage counter in ESD version contains black antistatic plastic bins.

1 SP-01

Full modular counter set consists of eight bin cabinets, each with 16 narrow bins and eight bin cabinets, each with 8 wide bins and technical connecting/turntable set. Full modular counter set is easily assembled of 16 bin cabinets placed in four levels, whereas each level contains four bin cabinets.



2 SP-01/S-1

Bin cabinet with 16 narrow bins.

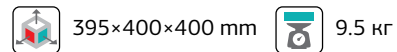

3 SP-01/S-2

Bin cabinet with 8 wide bins.

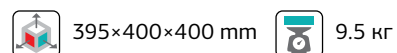

4 SP-01/K

Technical modules set that consists of

- 1** — turntable base,
- 2** — 3 connecting pads,
- 3** — top lid.

SP-01/S-1, SP-01/S-2 and SP-01/K modules are necessary to built up a customized modular set.

Standard SP-01 set includes technical pads, base and top lid.

When ordering, please mention whether ESD or technical version required.

MODULAR STATIONARY COUNTER

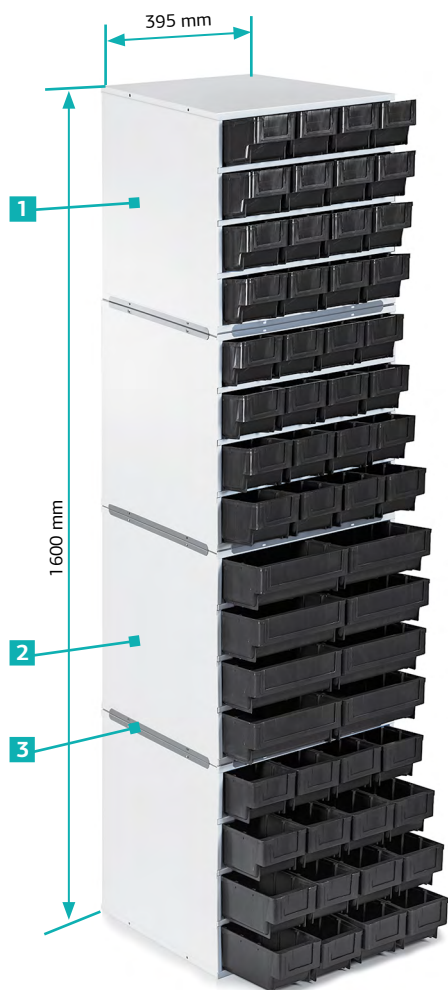

Stationary modular storage counter is a practical and compact solution for components and tools keeping, that can be placed anywhere in production hall.

Stationary modular counter is equipped with bin cabinets containing 2 types of plastic bins: narrow and wide.

- **narrow** bins with up to of 2.4 liter volume

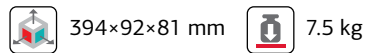

- **wide** bins with up to 4.3 liters volume

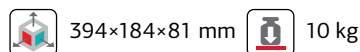

Modular storage counter in ESD version contains antistatic plastic bins.

Stationary modular storage counter is ordered in parts, bin cabinets and technical connecting pads separately. Maximum of 4 bin cabinets can be placed in a column.

1 SP-01/S-1

Bin cabinet with 16 narrow bins.

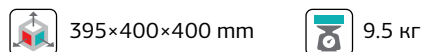

2 SP-01/S-2

Bin cabinet with 8 wide bins.

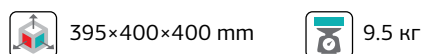

3 SP-01/PM

Connecting pad for bin cabinets.

Ordered if several bin cabinets need to be placed on one another to provide safer junction.

4 SP-01/C-1/D Dividers for narrow cases of the modular counter

They allow dividing the space inside a case. Max. 6 dividers can be places in one case.

5 SP-01/C-2/D Dividers for wide cases of modular counter

The allow dividing the space inside a case. Max. 6 dividers can be placed in one case.

6 SP-01/PPT Movable modular counter support

Movable modular counter support is designed to provide the mobility to modular counters. It has 4 casters with 50 mm diameter, 2 of which are with brakes. The stand can sustain 4 drawer units, which are established at each other.

4

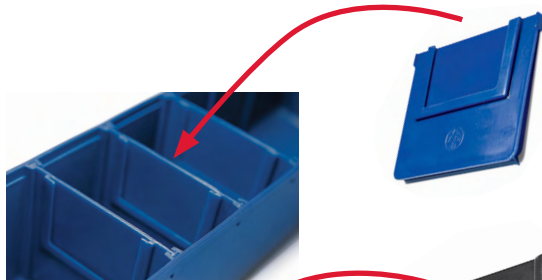

5



6



VKG TOOLS ANTISTATIC EQUIPMENT

ESD CHAIRS

VKG C-100 ESD



AESD laboratory chair, covered with static dissipative fabric, can be equipped with five conductive glides or five ESD casters. Can be also equipped with KT type ESD armrests, footrest and enlarged gaslift on request.

- Back angle adjustment
- Seat height adjustment: 43–63 cm
- Available colors: grey and blue

 7 kg

VKG C-200 ESD



ESD laboratory chair, covered with static dissipative fabric, can be equipped with five conductive glides or five ESD casters. Can be also equipped with KT type ESD armrests, footrest and enlarged gaslift on request.

- Back and seat angles adjustments
- Seat height adjustment: 43–63 cm
- Available colors: grey and blue

 7 kg

VKG C-300 ESD



ESD laboratory chair with conductive incombustible polyurethane upholstery can be equipped with five conductive glides or five ESD casters. Can be also equipped with KT type ESD armrests, footrest and enlarged gaslift on request.

- Back angle adjustments
- Seat height adjustment: 43–57 cm

 7.5 kg



VKG C-310 ESD



ESD laboratory chair with conductive incombustible polyurethane upholstery can be equipped with five conductive glides or five ESD casters. Can be also equipped with footrest and enlarged gaslift on request.

- Back angle adjustments
- Seat height adjustment: 43–57 cm

 8 kg



VKG C-320 ESD



ESD laboratory chair with conductive incombustible polyurethane upholstery can be equipped with five conductive glides or five ESD casters. Can be also equipped with KT-2 type ESD armrests, footrest and enlarged gaslift on request.

- Back angle adjustments
- Seat height adjustment: 43–57 cm

 8 kg



VKG C-330 ESD



ESD laboratory chair with conductive incombustible polyurethane upholstery can be equipped with five conductive glides or five ESD casters. Can be also equipped with KT-2 type ESD armrests, footrest and enlarged gaslift on request.

- Back and seat angles adjustments
- Seat height adjustment: 43–57 cm

 8.5 kg



1 VKG C-400 ESD

2 VKG C-410 ESD



ESD laboratory stool with conductive incombustible polyurethane upholstery can be equipped with five conductive glides or five ESD casters. Can be also equipped with ESD footrest and enlarged gaslift on request.

- Seat height adjustment: 43–63 cm
- Resistance: less than 1 MOhm
- Weight: 4 kg
- Cleanroom — suitable



Foot ring (support) for VKG series



Height-adjustable supportive foot ring. Recommended for chairs with extended gaslifts.

Ring diameter

- JR-430 — 43 cm
- JR-600 — 60 cm

Gaslifts for VKG series



KT-2 ESD armrests



A set of ESD armrests can be additionally ordered for VKG C-320, C-330 types of ESD chairs.

KT ESD armrests for VKG series



A set of ESD armrests can be additionally ordered for VKG C-100, C-200, C-300 types of ESD chairs.

ESD chairs and armchairs are originally equipped with KJ/200 gaslift, which allows to adjust seat height 43–63 cm from the floor. KJ/200 and KJ/260 gaslifts can be also ordered separately.

Seat height adjustment

- KJ/200 — 43–63 cm
- KJ/260 — 54–83 cm

VKG F-05 ESD glides for all chairs



A set of five ESD glides may be ordered for all types of ESD chairs and ESD stool.

P607A ESD casters for all chairs



A set of five black ESD casters may be ordered for all types of ESD chairs and ESD stool.

STREAM 280-SY



- 5 Cm cold-foam seat and 3.5 Cm cold-foam backrest
- Seat height adjustment : 43 cm –54 cm
- Available in 2 colors (black and grey)
- Extra strong aluminum 5-star base provides 120 kg load capacity
- Available in both esd and technical versions



STREAM 280-SY ESD Armchair is designed especially for workplaces where antistatic environment is required. It also provides individually adjustable ergonomic sitting. 5 years warranty guaranteed.

Can be equipped with ESD glides, ESD casters, armrests, higher gaslift with foot ring. For safety reasons a model equipped with higher gaslift and foot ring available only with glides.

GS CERTIFICATE fulfills standards:

- DIN EN 1335-1:2002-08 + B1:2002-11
- DIN EN 1335-2:2010-01
- DIN EN 1335-3:2009-08
- DIN EN 13761:2002-12

ERGONOMIC CERTIFICATE

fulfills the standard:

- DIN EN ISO 9241-5:1999-088
- TOX FREE CERTIFICATE pollutant free:
- Cadmium
- PAK
- Formaldehyd
- Azodyes

L607 A casters for all chairs



A set of five light-grey smudge free ESD casters may be ordered for all types of ESD chairs and ESD stool

Accessories for STREAM 280-SY



BR-207-1-CHR

Height-adjustable black nylon armrests, polypropylene arm pads.

- BR-AL-CHR-ESD — conductive type
- BR-207-1-CHR — insulating type

BR-AL-CHR-ESD



Aluminum armrests with fixed shape and height.

KJ/650-CHR



- Set of higher gaslift with foot ring
- Can be equipped with esd glides only
- Seat height 65–93 cm

GROUNDING AND ADDITIONAL EQUIPMENT

VKG A-9400 Connecting plug for grounding cables



White connecting plug for grounding cables with 1 MOhm resistor.

VKG A-3146 Grounding unit



Two 10 mm buttons ground wrist straps and devices via junction block.

VKG KH 4060, VKG KH 6090, VKG KH 12060 ESD mats



Fire-resistant and solder-resistant ESD mats. Supplied in a set with grounding cord.

- Antiglare matte surface
- Colors: blue, grey

CODE →	VKG KH 4060	VKG KH 6090	VKG KH 12060
Dimensions	400×600 mm	600×900 mm	1200×600 mm
Charge decay time	Less than 0.04 sec		
Typical resistance to ground	10 ⁵ ...10 ⁹ Ohm		

Antistatic Floor Mat TOROSTAT

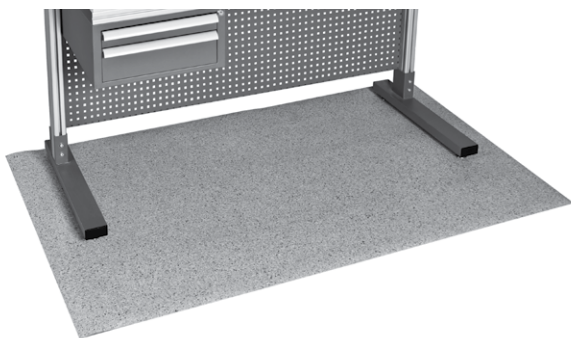

Double-layer anti-static floor mat 2.5 mm thick, abrasion resistant, sound-absorbing, non-flammable, thermally stable, dissipative top layer and conductive bottom layer: dripping time charge from 1000 V to 50 V in less than 0.5 seconds, the resistance of the ground — less than 100 MΩ, the combined resistance — less than 35 MΩ. Various dimensions: 150 mm×200 to 1000×10000 mm.

VKG G-01 Universal grounding unit



Universal grounding unit compatible with most popular wrist strap connections : banana plug, GSGS, 4, 4.5, 7 and 10 mm snaps.

- Grounds up to two single wrist straps
- 3 meter cord with eyelet
- No resistor

Should be mounted underneath tabletop and devices via junction block.

Wrist strap coil cords



1 MΩ resistor (Wrist strap connection side). Types of connections to fit most grounding systems worldwide. Female stud connections. Black color. Suitable to connect to a ground via VKG G-1

CODE	DESIGNATION	CORD LENGTH
30-560-0604	6' COIL CORD 4 mm / banana + crocodile clip	1.80 m
30-560-1004	12' COIL CORD 4 mm / banana + crocodile clip	3.00 m
30-560-0641	6' COIL CORD 4 mm / 10mm	1.80 m
30-560-0614	6' COIL CORD 4 mm / GSGS	1.80 m
30-560-0645	6' COIL CORD 4 mm / 4.5 mm	1.80 m
30-560-1014	10' COIL CORD 4 mm / GSGS	3.00 m

ESD Wrist straps



- VKG A-2202 conductive fabric wrist strap with 4 mm button and a 4 mm to 10 mm buttons cord
- VKG A-2202-0 conductive fabric wrist strap with 4 mm button
- VKG A-2210 conductive metal wrist strap with 4 mm button and a 4 mm to 10 mm buttons cord
- VKG A-2210-0 conductive metal wrist strap with 4 mm button

FULLY AUTOMATED TURNSTILE SYSTEM

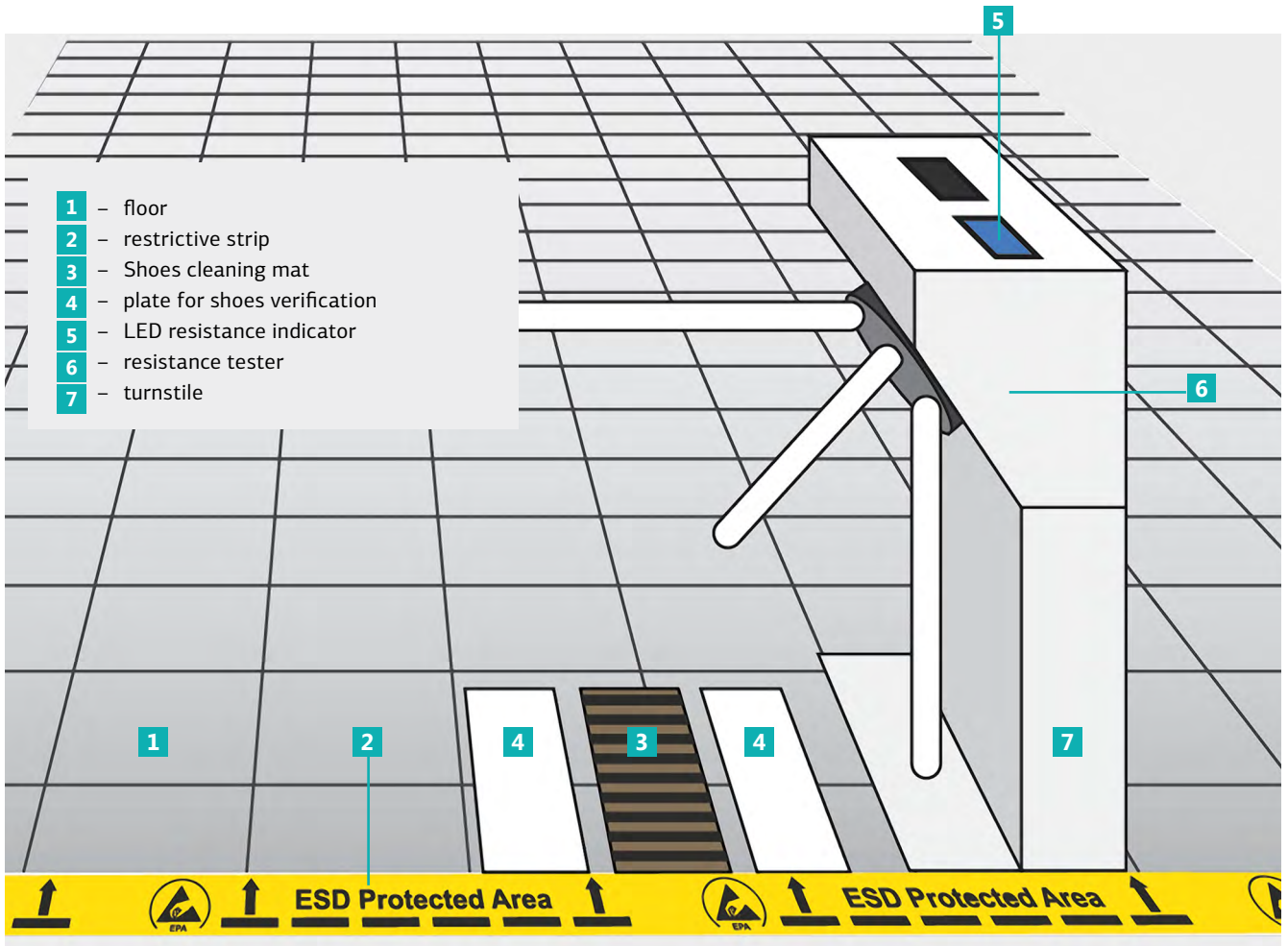

Fully automated turnstile system. For companies who need to ensure that the operators cannot enter the EPA unless their wrist straps and footwear are compliant every day.

The turnstile complies with ANSI/ESD S20/20 specification and ISO standards record keeping requirements.

This system tests operators quickly and automatically and will generate reports and e-mail results simultaneously to the ESD coordinator.



- Turnstile Dimensions: 42×33×98 cm (W×D×H)
- Clear passage width: 51 cm
- Weight: 30 kg
- Values indications: Red and green led, different for each kind of equipment
- Voltage measurement: Measurement under permanent voltage of 20V +/- 5%
- Warning: acoustic signal and green arrow/red no entry logos
- Material: stainless steel Shoes electrodes
- Dimensions: 36×36 cm (L×W)
- Weight: 2.15 kg
- Features: Electrodes left foot and right foot
- Compliant with:
 - 2006/95/CE Directive — low voltage
 - 2004/108/CE Directive — electromagnetic compatibility IEC 61340-5-1.
- 2 versions:
 - Automated turnstile system with footwear and wrist straps testers (61-200-3103).
 - "HIGH RANGE" automated turnstile system with card reader, footwear and wrist straps testers (61-200-3106).

ESD GARMENTS

ESD garments shield external objects from electrostatic discharge, which is generated on internal garments by friction.

VA Unisex Shortcut lab coat



- Machine washable at 60 °C
- At least 50 washing cycles without losing ESD characteristics
- Charge decay time: < 0.17 s
- Composition:
 - 54% polyester
 - 43% cotton
 - 3% conductive fibers
- Colors:
 - white
 - blue
 - grey

VAE-M Men's lab coat, VAE-W Women's lab coat



- Machine washable at 60 °C
- At least 50 washing cycles without losing ESD characteristics
- Charge decay time: < 0.17 s
- Composition:
 - 54% polyester
 - 43% cotton
 - 3% conductive fibers

VH-01 Antistatic bandana



Material:

- 54% polyester
- 43% cotton
- 3% conductive fibers

Colors:

- blue
- white
- grey

When ordering, mention necessary height (152-194 mm) and size (EUR 34-54).

VAK-M Men's costume, VAK-W Women's costume



- Machine washable at 60 °C
- At least 50 washing cycles without losing ESD characteristics
- Charge decay time: < 0.17 s
- Composition:
 - 54% polyester
 - 43% cotton
 - 3% conductive fibers
- Colors:
 - white, blue, grey
 - white and blue combined
 - white and grey combined

VAT-W Women's trousers VAT-M men's trousers



- Machine washable at 60 °C
- At least 50 washing cycles without losing ESD characteristics
- Charge decay time: < 0.17 s
- Composition:
 - 54% polyester
 - 43% cotton
 - 3% conductive fibers
- Colors:
 - white
 - blue
 - grey

VH-02 Antistatic cap

Material:

- 54% polyester
- 43% cotton
- 3% conductive fibers

Colors:

- blue
- white
- grey

Elastic band

Sizes:

- 54-62



CLEANROOM GARMENTS AND ACCESSORIES

Cleanroom Labcoats



Coats are intended for use in cleanrooms up to ISO Class 5 category.

- Surface resistance 10^6 - $10^9 \Omega$.
- Durability — up to 80 washes at 60°C.
- Material: Polyester.
- Colors: white and blue.
- Sizes: S, M, L, XL, XXL, XXXL.

Cleanroom Jumpsuits



Jumpsuits are intended for use in cleanrooms up to ISO Class 5 category

- Surface resistance 10^6 - $10^9 \Omega$.
- Durability — up to 80 washes at 60°C.
- Material: Polyester.
- Colors: white and blue.
- Sizes: S, M, L, XL, XXL, XXXL.



CODE	SIZE	COLOR
51-400-0001	S	White
51-400-0002	M	White
51-400-0003	L	White
51-400-0004	XL	White
51-400-0005	XXL	White
51-400-0006	XXXL	White
51-400-0101	S	Blue
51-400-0102	M	Blue
51-400-0103	L	Blue
51-400-0104	XL	Blue
51-400-0105	XXL	Blue
51-400-0106	XXXL	Blue

CODE	SIZE	COLOR
51-400-0201	S	White
51-400-0202	M	White
51-400-0203	L	White
51-400-0204	XL	White
51-400-0205	XXL	White
51-400-0206	XXXL	White
51-400-0301	S	Blue
51-400-0302	M	Blue
51-400-0303	L	Blue
51-400-0304	XL	Blue
51-400-0305	XXL	Blue
51-400-0306	XXXL	Blue

Cleanroom Boots



Boots are intended for use in cleanrooms up to ISO Class 5 category.

- Resistance to ground $<3.5 \times 10^7 \Omega$
- Materials:
 - Top: Micro Fibre Synthetic PU;
 - Sole: Static Dissipative PU;
 - Fabric: Static Dissipative Polyester
- Washable
- Color: white

CODE	SIZE
50-530-0035	35
50-530-0036	36
50-530-0037	37
50-530-0038	38
50-530-0039	39
50-530-0040	40
50-530-0041	41
50-530-0042	42
50-530-0043	43
50-530-0044	44
50-530-0045	45
50-530-0046	46

Disposable Labcoats



Disposable labcoats are intended for use in cleanrooms up to ISO Class 6 category.

- Material: SMS (Spunbonded Meltblown Spunbonded), Density: 60 g/sqm, closed with plastic studs, 3 pockets
- Non-washable.
- Color: white
- Sizes: L, XL, XXL

Disposable Hat



Disposable hats are intended for use in cleanrooms up to ISO Class 5 category.

- Material: SMS (Spunbonded Meltblown Spunbonded), Density: 20 g/sqm.
- Non-washable.
- Color: white

CODE

PACKAGE QTY

52-100-0001

100

Face Mask



Masks are intended for use in cleanrooms up to ISO Class 5 category.

- Material: three-layer polypropylene
- Color: white

CODE

SIZE

52-100-4203

L

52-100-4204

XL

52-100-4205

XXL

Cleanroom Gloves



Hypoallergenic gloves for cleanrooms, available in lengths of 23 cm and 30 cm, intended for use in cleanrooms up to ISO Class 5 category.

- Material: Nitrile
- Surface resistance: $< 10^{11} \Omega$
- Sizes: S, M, L

CODE

SIZE

PACKAGE QTY.

52-000-0060

N/A

100

Cleanroom Overshoes



Overshoes are intended for use in cleanrooms up to ISO Class 5 category.

- Material: SMS (Spunbonded Meltblown Spunbonded), Density: 50 g/sqm.
- Color: white

CODE

SIZE

PACKAGE QTY.

52-100-0014

N/A

100

CODE

SIZE

LENGTH

PACKAGE QTY.

51-690-0701

S

23 cm

10

51-690-0702

M

23 cm

10

51-690-0703

L

23 cm

10

51-690-0704

S

30 cm

10

51-690-0705

M

30 cm

10

51-690-0706

L

30 cm

10

PUREX FUME EXTRACTION SYSTEMS



The soldering process itself can produce some harmful fumes. These fumes can cause occupational asthma, long-term carcinogenic diseases and other serious complaints. The result of these illnesses can be expensive compensation claims from employees, long-term sickness and poor employee relations, plus heavy penalties from enforcement agencies.

Purex fume extraction systems are designed in conjunction with some of the world's largest Contract Electronics Manufacturers and Equipment Providers to help:

- Prevent damage to production machinery.
- Reduce downtime for cleaning and maintenance.
- Protect personnel from harmful fumes.
- Reduce product rejects due to poor production performance.
- Maintain a constant extraction rate to ensure stable temperature profiles.
- Deliver long filter life.
- Interface with the production equipment.

Fume Cube line units are used for:

- Soldering assembly
- Gluing and chemical treatments
- Laboratory/cleanroom tasks
- Rework and repair

The FumeCubeLITE is a low cost, portable system for one or two users, Fume Cube and Fume Cube 2 are more sophisticated and functional arm extraction and purification systems, which are used to protect personnel from hazardous particles and fumes.

System Features:

- Precision made from stainless steel
- Low capital and running costs
- Quick change pre-filters deliver longer filter life
- Submicronic (HEPA) filtration removes 99.997% of particles down to 0.3 microns
- Activated carbon filtration removes harmful gas
- Simple to install and quiet in operation
- Easy to relocate
- Optional interfacing option

TECHNICAL FEATURES

Voltage (V)	230 (120)
Frequency (Hz)	50/60
Wattage (kW)	0.14 (0.107)
ON/OFF switch	On rear
Power cable	2 m
Noise intensity, dBA	60
Dimensions (mm):	308×294×366





1



2



3

	FUMECUBE ^{LITE}	FUMECUBE	FUMECUBE 2
Picture number	1	2	3
Code	072100	072066	072065
Number of arms	1 or 2	1	2
Filters pre-installed	Pre filter pad + main HEPA/Chemical filter		
Warning system	—	VariColour filter blocked warning system	
Airflow	Fixed airflow — 190m ³ /hr in free air	Automatic flow control and speed control (adjustable airflow)	
Arm kit	One or 2 pieces of 100294, 100295 or 100295 ESD kits should be ordered separately		

100294 Kit



100295 Kit



Optional accessories

TYPE OF ACCESSORIES	ORDERING CODE
Remote ON/OFF switch	TBA
FLEXIBLE ARM KIT with Screw Bracket without Conical cowl and Pen-nib nozzle	100294
FLEXIBLE ARM KIT with Clamp Bracket	100295
FLEXIBLE ARM KIT- ESD Version with Clamp Bracket	100295 ESD
Cleanroom filters	110538
Chemical filters	110537
Double chemical filters	110536



Wide range of fume extractors for laser engraving, tip extractions, reflow or wave soldering up to 36 arms, 50 iron tips and over 3000 m³/hr is available. Ask us for more details.

ESD STORAGE AND PACKAGING

STANDARDIZED ESD TRAYS FOR BOARDS AND COMPONENTS STORAGE

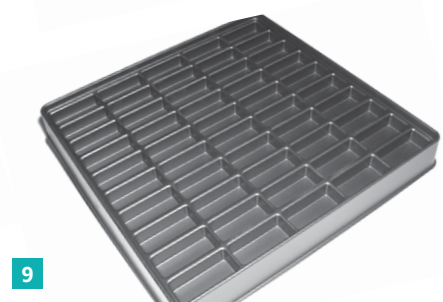
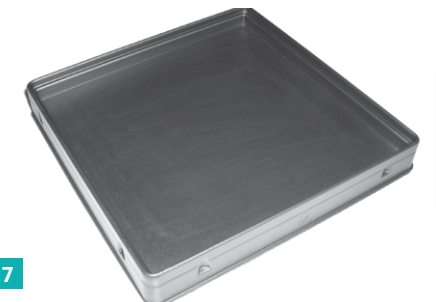

ESD trays are used for storage, transport and packaging of boards, components and finished units of electronic assembly. Made of conductive carbon-loaded PS —dissipative material resistance $\leq 10^4 \Omega$. Color — black.

Nr	CODE	DIMENSIONS	THICKNESS	NUMBER OF CELLS	DIMENSIONS OF EACH CELL
1	24-204-0650	330×250×50 mm	3.0 mm	12	66×56 mm
2	24-204-1486	294×194×20 mm	1.8 mm	15	30×75 mm
3	24-204-2273	350×225×20 mm	3.0 mm	24	44.57×46.86 mm
4	24-204-2274	350×225×20 mm	3.0 mm	6	101×98 mm
5	24-204-2531	350×225×20 mm	3.0 mm	6	48×208 mm
6	24-204-2532	350×225×20 mm	3.0 mm	12	97.2×45.9 mm
7	24-204-2819	210×210×24 mm	1.2 mm	1	192×192 mm
8	24-204-2820	210×210×24 mm	0.8 mm	25	36×36 mm
9	24-204-2821	210×210×24 mm	0.8 mm	50	36×15 mm
10	24-204-4526	295×120×60 mm	1.5 mm	1	100×275 mm

ANTISTATIC STORAGE

COCIS antistatic bins



Conductive ESD bins are used for small components and tools storage. Made of antistatic polypropylene. Can be easily attached to bin rails or fitted for free standing on a grounded surface. Bins of equal width can be stacked on one another.

CODE	OUTER DIMENSIONS	INNER DIMENSIONS
COCIS-A	107 × 98 × 47 mm	92 × 83 × 42 mm
COCIS-B	170 × 105×75 mm	130 × 93 × 68 mm
COCIS-C	250 ×150 × 130 mm	185 × 135 × 122 mm
COCIS-E	350 × 230 × 150 mm	265 × 206 × 140 mm

Conductive Polypropylene Containers

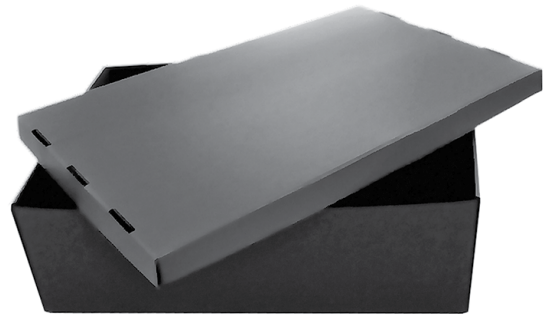

- Thickness — 2.5 mm
- Delivered unassembled
- Apertures for easy carrying on each side

CODE - BOX	CODE - LID	OUTER DIMENSIONS (MM)
23-175-7108	23-175-7110	400 × 300 × 180
23-175-7109	23-175-7110	400 × 300 × 228
23-175-7104	23-175-7106	600 × 400 × 180
23-175-7105	23-175-7106	600 × 400 × 228

Modular ESD trays

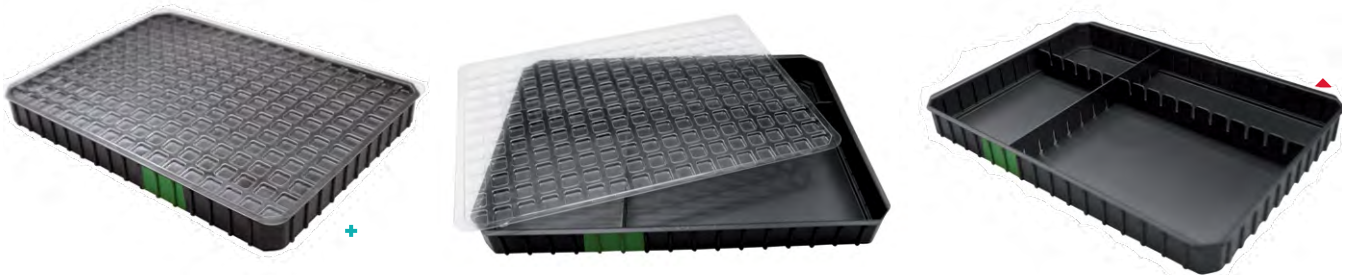

Standard range of trays with a set of modular dividers. This new item will reply to various need for convenient storing and transporting small PCB's on sensitive components.

Stackable tray for components storage with transparent lid and removable dividers that should be ordered separately. Lid and dividers are clipped on the tray.

The system with dividers provides the possibility to organize 2 to 204 cells for components storage. Minimum size of the cell is 15×15 mm

TYPE OF UNIT	ESD TRAY FOR PCB'S	TRANSPARENT LID FOR THE TRAY	SHORT DIVIDERS (11 NOTCHES)	LONG DIVIDERS (15 NOTCHES)
Code	24-401-9428	24-213-9429	23-177-9431	23-177-9430
Material	Dissipative PS	Clear APET	Conductive PS	Conductive PS
Thickness, mm	1.5	0.8	1.8	1.8
Dimensions, mm	355×255×36	355×255×5	247×2×30	347×2×30

Useful height of the tray with lid — 28 mm

ESD MAGAZINES



- Vertical pitch 10 mm
- Width adjustable by 5 mm pitch
- Strong construction from thermoformed plastic with metal reinforcement
- Light in weight and extremely rigid
- Assembled using rivets and ultrasonic welding

- Each groove is numbered
- Each magazine is delivered with a partition

2 versions available:

- PS for a 60°C heat resistance
- ABS/PC for 110°C heat resistance

PS magazines

Extra partitions and lids available on request.

ABS/PC magazines

Extra partitions and lids available on request.

CODE	DIMENSIONS	PCB	CODES FOR ADJUSTABLE PLATES
22-150-0943	320×350×560	247	97-001-0003
22-150-1154	370×370×560	297	97-001-0003
22-150-1187	400×425×560	327	97-001-0001
22-150-0817	420×460×560	357	97-001-0001
22-150-0891	450×425×560	377	97-001-0007
22-150-1083	470×480×560	397	97-001-0007

CODE	DIMENSIONS	PCB	CODES FOR ADJUSTABLE PLATES
22-151-0943	320×350×560	247	97-011-0005
22-151-1154	370×370×560	297	97-011-0005
22-151-1187	400×425×560	327	97-011-0001
22-151-0817	420×460×560	357	97-011-0001
22-151-0891	450×425×560	377	97-011-0003
22-151-1083	470×480×560	397	97-011-0003

CUSTOMIZED TRAYS FOR BOARDS AND COMPONENTS STORAGE

1 Customized packaging and shipping trays for PCB and components handling



Customized packaging and shipping trays are developed to specific customer needs and requirements to handle most PCB's and ESSD's. The complete process is controlled — the mold design and manufacturing and sheet extrusion production.

If we do not have a standard or common tray to suit your needs, if you require 100 off or 100 000 off. Speak to our technical sales team.



Quickfill Magazine

Quickfill magazines meet standard dimensions most frequently used on automated lines. Strong injection molded construction with metal reinforcement (top and bottom). Standardized plate that fits most popular brands on the market.

- Not subject to accidental change in width; no wear of moving parts
- Partition made of assembled plastic parts
- This system provides a better dimensional stability when strong temperature variations
- Meant for 50 PCB's

Material: Conductive PS (60°C heat resistance) or ABS/PC (110°C heat resistance) for plastic parts, galvanized Iron for metal parts.

CODE	DIMENSIONS	MATERIAL VERSION	MIN./MAX. PCB SIZE
22-152-3060	460×400×563	PS	50/300
22-152-4060	355×320×563		50/250
22-152-6060	460×400×563		100/310
22-152-7060	535×460×570		50/390
22-152-8060	535×530×570		120/460
22-152-1120	460×400×563	ABS/PC	50/300
22-152-2120	355×320×563		50/250
22-152-3020	535×460×570		50/390

2 Customized foam inserts



Customized foam inserts are made to order per customer specification, using conductive or dissipative antistatic foam —thickness 3–12 mm and a density 24–45 Kg/m³.

ESD PACKAGING

Black Conductive Tubing



- Complies with: 61340-5-1, 94/62/EC, 2002/95/EC
- Surface resistance: $<10^5 \Omega$
- Thickness: $100\mu (\pm 10\%)$

CODE	DIMENSIONS (m)
20-851-0005	0.076 × 152
20-851-0010	0.102 × 152

Non-standard dimensions available.

Pink Dissipative Tubing



- Complies with: 61340-5-1, 94/62/EC, 2002/95/EC
- Surface resistance: $<10^{12} \Omega$
- Thickness: $90\mu (\pm 10\%)$
- Decay Time: from 1000V to 100V $< 2 \text{ c}$
- Shelf life: 2 years

CODE	DIMENSIONS (m)
20-031-0005	0.1 × 250
20-031-0015	0.15 × 250
20-031-0020	0.2 × 250
20-031-0025	0.25 × 250
20-031-0030	0.3 × 250
20-031-0035	0.4 × 250
20-031-0040	0.5 × 250

Non-standard dimensions available

Dissipative Foam

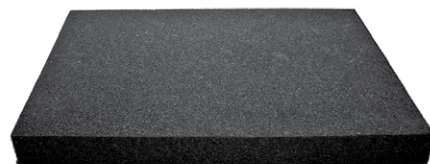

CODE	DIMENSIONS (mm)
26-403-0025	355 × 255 × 3
26-403-0008	555 × 355 × 3
26-412-0006	355 × 255 × 12
26-412-0005	555 × 355 × 12
26-406-0001	355 × 255 × 6
26-406-0002	555 × 355 × 6

Dissipative foam used in packaging to protect an object from mechanical damage. It also improves the shielding characteristics of the packaging.

ESD CARDBOARD BOXES

Conductive coating and ESD marking. Non-standard dimensions available.

ESD boxes with pink PU foam



- 1 Static shielding and physical protection for small components
- 2 Static shielding and physical protection for PCBs

Supplied with pink PU flat foam on bottom and under lid.

CODE	DIMENSIONS (mm)
25-402-0105	40 × 40 × 15
25-402-0110	60 × 60 × 25
25-402-0115	100 × 100 × 38
25-402-0120	135 × 50 × 20
25-402-0205	178 × 127 × 38
25-402-0210	229 × 191 × 38
25-402-0215	229 × 191 × 64
25-402-0220	267 × 216 × 64
25-402-0225	318 × 267 × 64
25-402-0230	394 × 318 × 64
25-402-0235	521 × 394 × 38
25-402-0240	521 × 394 × 64

ESD boxes with black PU foam



- Static field alternative and physical protection for shipping Microchips EPROMS/SIMMS.

Supplied with rigid foam on bottom.

CODE	DIMENSIONS (mm)
25-402-0005	90 × 30 × 15
25-402-0010	100 × 60 × 15
25-402-0015	120 × 100 × 15
25-402-0020	140 × 40 × 15
25-402-0025	160 × 80 × 15

CATALOG LEGEND



Dimensions of the product/module



Link to additional information about the product



Load capacity of the product/module



Weight of the product/module



Possible height adjustment of the working surface



Depth of the product/module



Maximum impermanent temperature impact



The product/module is available in ESD version



The product/module is available in Technical version



The product/module is available in dark grey RAL 7012 color



The product/module is available in light grey RAL 7035 color



The product/module is bicolored by default and available in combination of dark grey RAL 7012 and light grey RAL 7035 colors



The product/module is bicolored by default and available in combination of light grey RAL 7035 and turquoise RAL 5021 colors



The product/module is multicolored by default and available in combination of black RAL 9005, white RAL 9010 and turquoise RAL 5021 colors



The product/module is available in black RAL 9005



The product/module is available in white RAL 9010



The product is cleanroom suitable

 2019

TECHNICAL & ESD FURNITURE ANTISTATIC EQUIPMENT

VIKING



 **DIPPAUL**

PLZENSKA 155/113
150 00 PRAGUE 5
CZECH REPUBLIC
TEL: +420 2 5573 9633
E-MAIL: INFO@DIPPAUL.EU
[HTTPS://VIKING-ESD.COM](https://VIKING-ESD.COM)